

Honda Pioneer 700 Quick-Mount 3500lb. Winch Kit



Product Instructions | Part No: 26-1040

Application: Honda Pioneer 700, verify accessory fitment at Kolpin.com.

Before You Begin: Read these instructions and check to be sure all parts and tools are accounted for. Please retain these installation instructions for future reference and parts ordering information.

Note: If any hardware is missing, do not return to the store. Call us to help, Toll Free 1-877-956-5746.

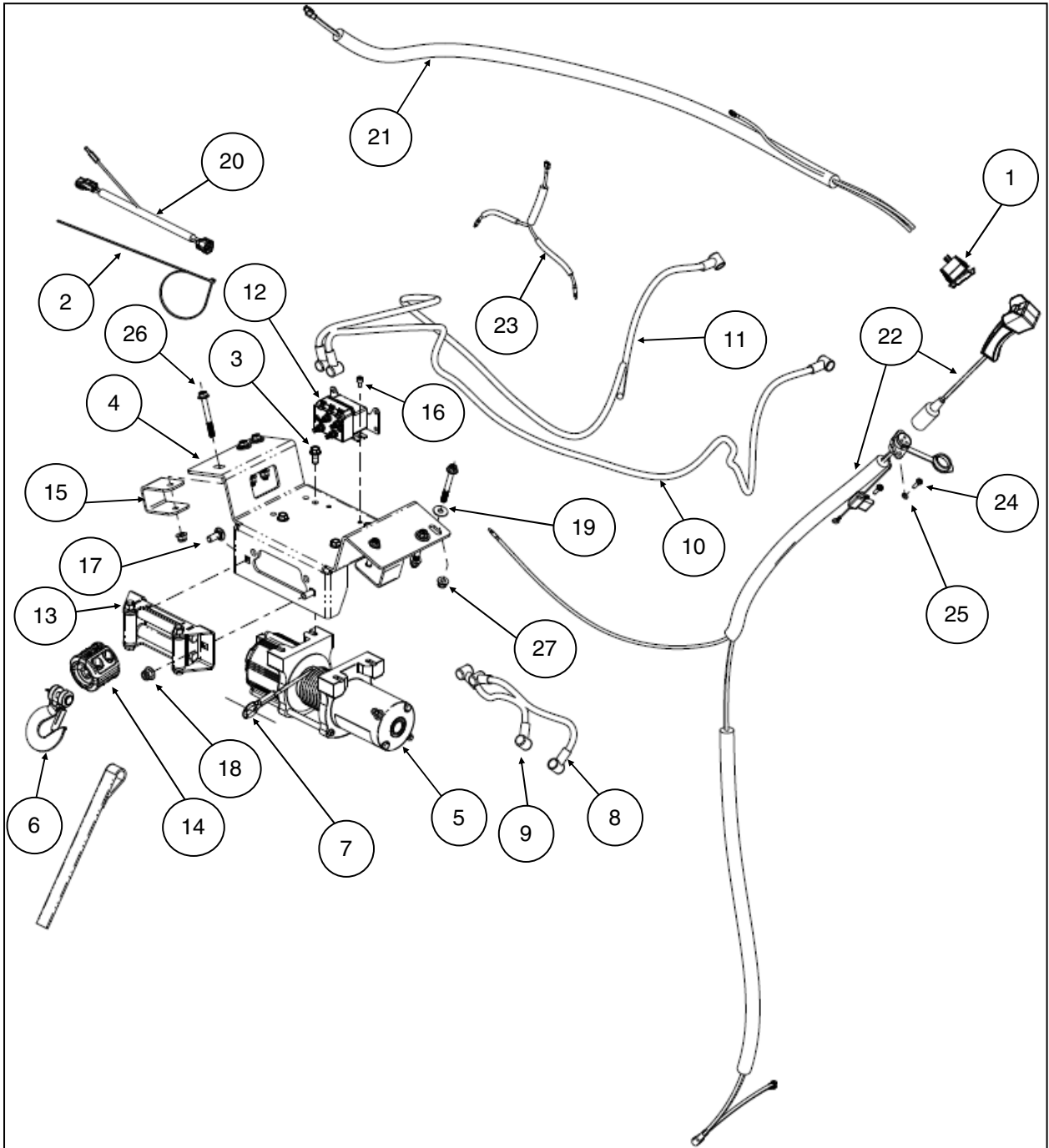

This Kit includes:

Item	Qty	Part Description	Part Number
1	1	Dash Switch, Panel Mount	4015688
2	10	Cable Ties, Nylon	-
3	4	Hex Flange Screw, Zinc Plated, M8 x 1.25 - 20mm LG	-
4	1	Mounting Bracket	25-1280
5	1	Winch - Kolpin, 3500lb.	25-9350R
6	1	Hook, Winch Latch	RPR0108
7	1	Winch Cable, Synthetic - 3500lb.	85065
8	1	Winch Connection Cable, Yellow 6 GA (280mm)	-
9	1	Winch Connection Cable, Blue 6 GA (280mm)	-
10	1	Power Connection Cable, Black 6 GA (1880mm)	-
11	1	Power Connection Cable, Red 6 GA (1924mm)	-
12	1	Contactor, Solenoid, 12V	85068
13	1	Roller Fairlead, Wide Pattern	85087
14	1	Rubber Winch Stopper	85080
15	2	U Bracket Clamp	-
16	2	Socket Head Cap Screw, Zinc Plated, M6 x 1.0 - 10mm LG	7517337
17	2	Carriage Screw, Zinc Plated, M10 x 1.5 - 25mm LG	7519372
18	2	Hex Flange Locknut, Zinc Plated, M10 x 1.5	7547423
19	4	Flat Fender Washer, Zinc Plated, M8	7556045
20	1	Pioneer Vehicle Accessory Power Harness	-
21	1	Pioneer Vehicle Dash Switch Harness	-
22	1	Pioneer Vehicle Corded Remote Switch & Harness	-
23	1	Pioneer Vehicle Accessory Power Splitter Harness	-
24	2	Pan Head Screw, Zinc Plated, #10 x 0.75" LG	-
25	2	Flat Washer, Zinc Plated, M5	-
26	6	Hex Flange Screw, Zinc Plated, M8 x 1.25 - 70mm LG	-
27	6	Hex Flange Locknut, Zinc Plated, M8 x 1.25	7547317
28	1	Instruction Guide (not shown)	-
-	-	Service Free Spool Handle Knob (not included in kit)	85072

Tools Required:

- Drill or cutting tools for plastic
- Socket Set, Torx Bit
- Pliers
- Safety Glasses
- Hex Key Set, Metric
- 1" Hole Saw or Drill Bit
- Torque Wrench
- Socket Set, Metric
- Wrench Set, Metric
- Electric Drill or Dremel tool

Assembly Time: Approximately 30 minutes

Note: The 26-1040 kit comes mostly assembled from factory. Some assembly is required.

Important: Your Kolpin Pioneer Quick-Mount Winch Kit is exclusively designed for your vehicle. Please read the installation instructions thoroughly before beginning. Installation is easier if the vehicle is clean and free of debris. For your safety, and to ensure a satisfactory installation, perform all installation steps correctly in the sequence shown. Additional time may be required to accommodate other installed accessories.

PIONEER 700 PREPARATION:

1. Shift vehicle transmission into "PARK". Turn key to "OFF" position and remove from vehicle.
2. To gain access to electrical connections, open the front hood and remove as shown. (See illustration 1-1). Remove passenger seat bottom.
3. Disconnect black (negative) and red (positive) cables from battery.

⚠ WARNING ⚠

ALWAYS disconnect black negative (-) cable from battery **FIRST**. Failure to do so will result in high current electrical arc, and may result in battery explosion if tool touches grounded frame. Death or serious injury may occur.

4. Remove the screws and front bumper as shown. Save all for re-install later. (See illustrations 1-2, 1-3 and 1-4). **Note, the 6mm and 10mm bolts will be re-used for bumper installation later.**
5. Remove the Pioneer winch assembly from the packaging.

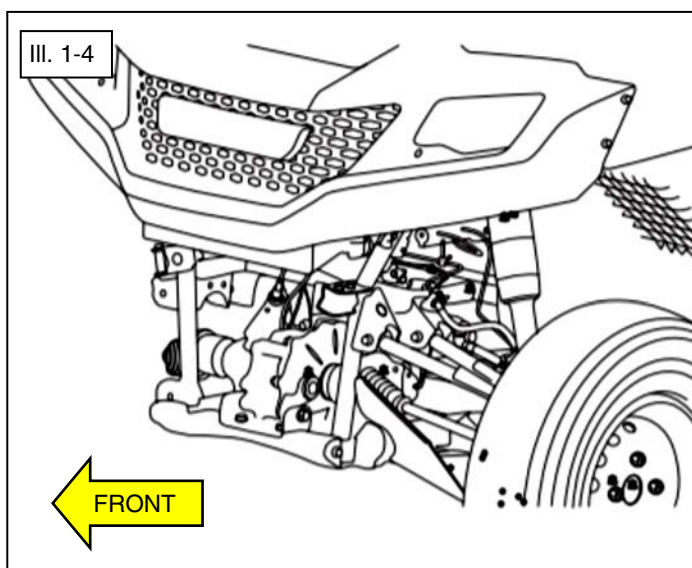
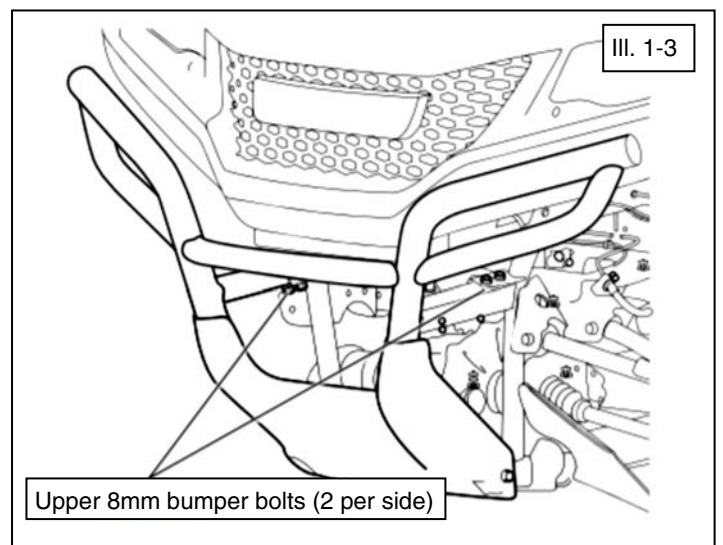
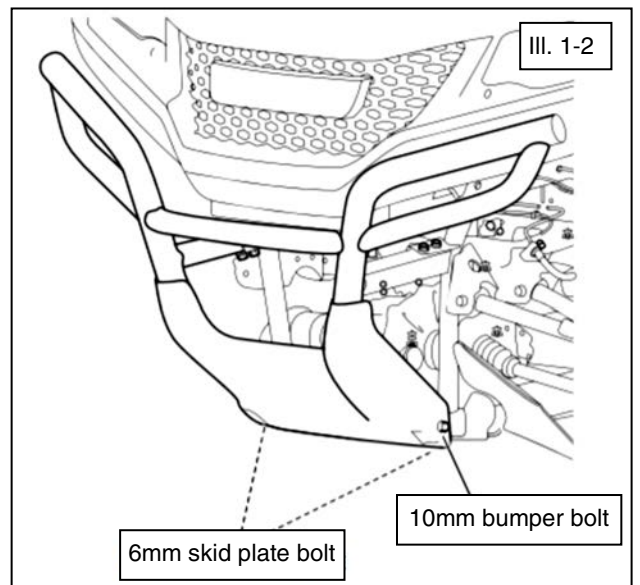
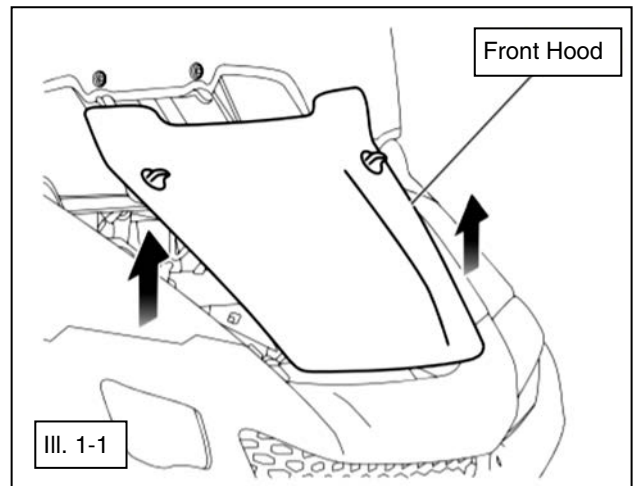

PIONEER 700 WINCH INSTALLATION:

NOTE: See the *Electrical Connections Reference Guide* section of the instruction manual for detailed photos of each part and their respective connections.

6. Position the winch sub-assembly into the front bumper as shown. (See illustration 1-5).
7. Place the M8 flat washers (item #19) over four M8 long bumper bolts (item #26) and temporarily insert through the mounting bracket (item #4) and into the bumper holes as shown. This will keep the mount aligned into the bumper. (See illustrations 1-6 and 1-7).
8. Assemble the mounting bracket to the front bumper using the U – Bracket Clamps (item #15) and two M8 long bolts (item #26). Place the U-Bracket over the bumper frame tube as shown. Insert the bolts thru the winch bracket and U - Bracket and then fasten using M8 locknut (item #27). (See illustration 1-7).
9. Tighten the M8 fasteners to torque specification.

 = T
8MM FASTENER TORQUE: 17 ft. lbs. (23 Nm)

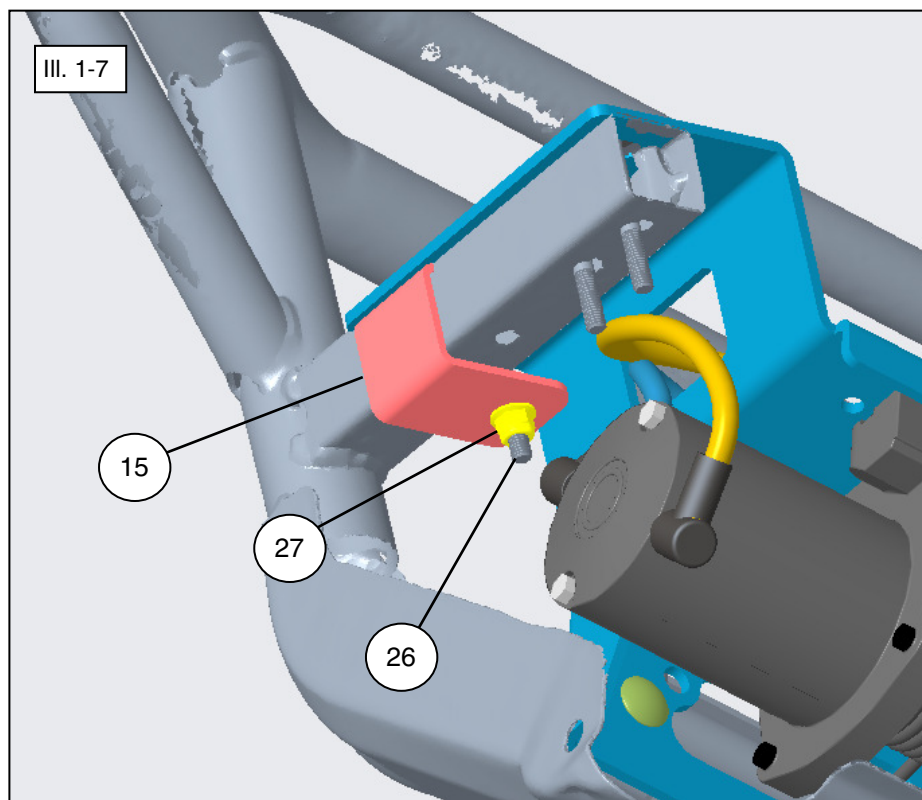
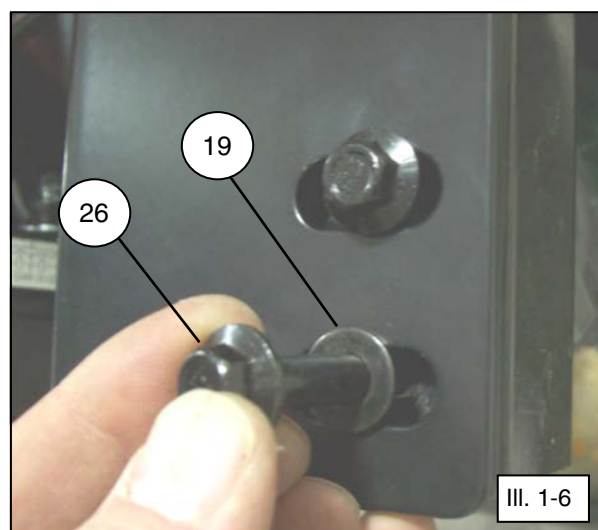
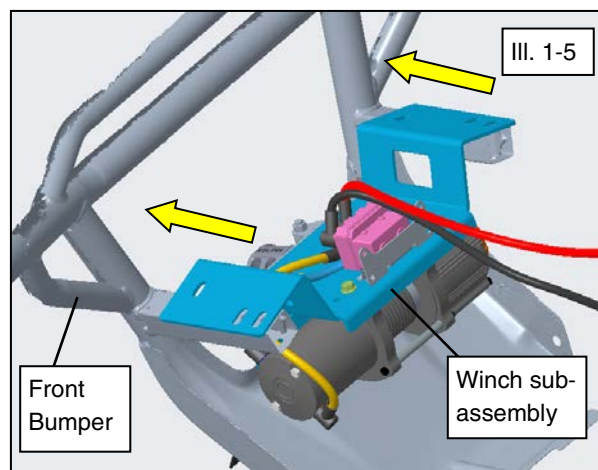

**PIONEER 700 WINCH INSTALLATION
(continued):**

- 10. Locate the red and black wires on winch assembly. If they are secured together as a bundle with a plastic tie, cut the tie to allow the wires to be routed properly.
- 11. Install winch-bumper assembly onto the frame re-using the OEM hardware removed in step 4. Check that all wires are free to move and not pinched between the vehicle chassis and the winch-bumper assembly. Route the black and red power cables first into window above front gearcase as shown. (See illustration 1-8).

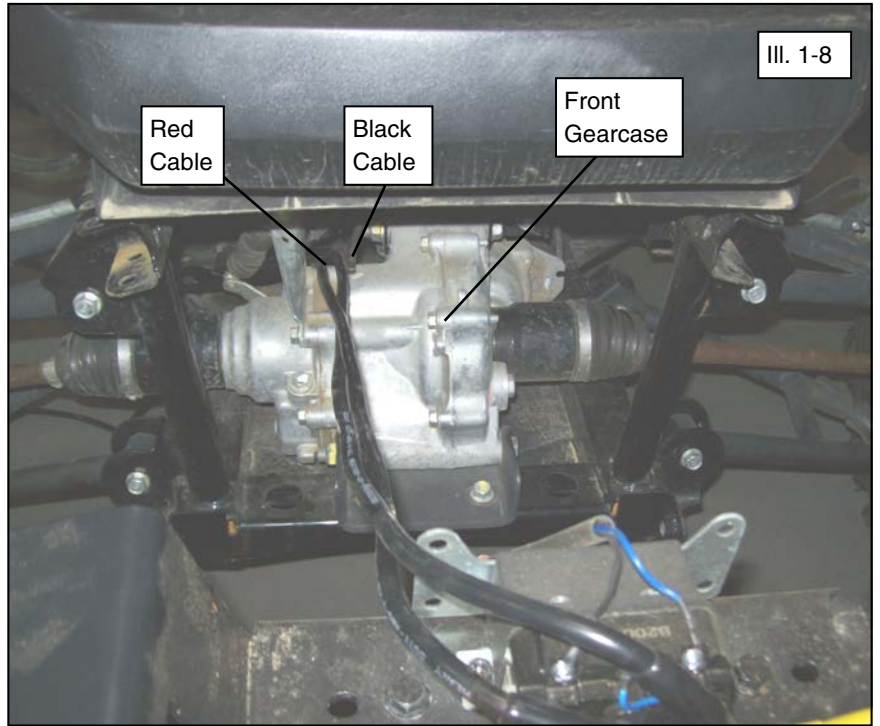

- 12. Install M8 flat washers (item #19) over the mount bracket slotted upper holes for the front bumper, then initially thread by hand, the four upper M8 bolts (item #26) into the four locations, two per side. Fasten the four bolts using M8 locknuts (item #27). Thread initially by hand, the OEM lower M10 bolt into the two locations, one per side as shown. Re-install the lower M6 OEM bolts into the skid plate. (See illustrations 1-9 and 1-10). **Note, the four M8 OEM upper bumper bolts and nuts will not be re-used. The M8 hardware supplied in kit will be used instead.**

- 13. Tighten the four M8 upper bumper screws, two M10 lower bumper bolts and two M6 skid plate bolts to torque specifications listed on next page.

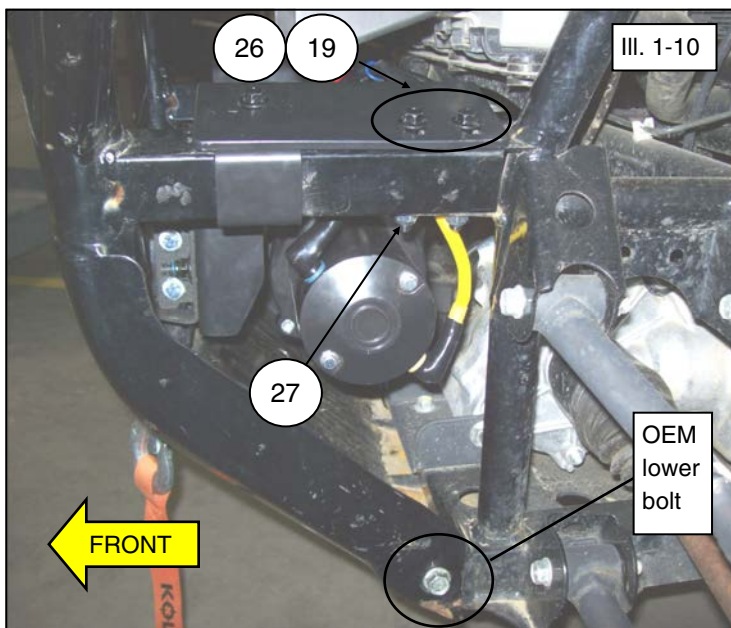
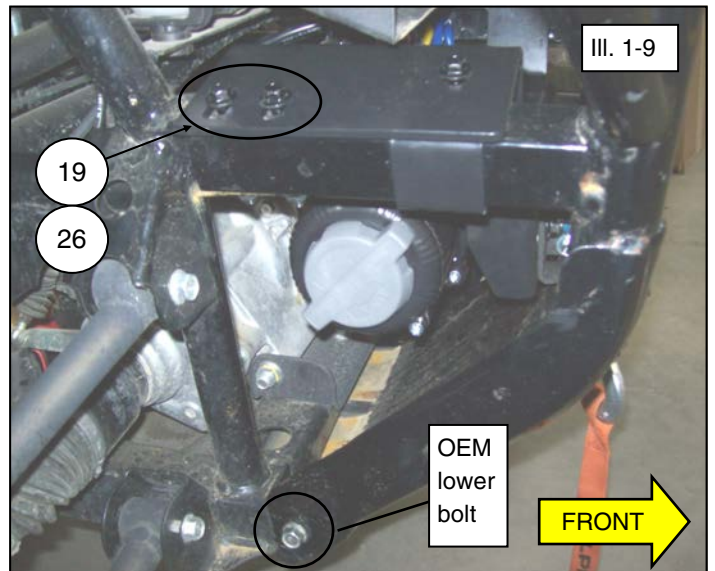

 = T
SKID PLATE 6MM FASTENER TORQUE: 8.9 ft. lbs. (12 Nm)

PIONEER 700 WINCH INSTALLATION (continued):

14. The front bumper fastener torques are listed on the tables to the right.
15. Route red positive (item #11) and black negative (item #10) power connection cables directly underneath the radiator, continue under the steering pinion rack, along the frame, under passenger seat, to reach the battery as shown. Using two of the plastic cable ties (item #2), loosely secure the red and black power cables to the frame and existing wiring. (See illustrations 1-11, 1-12, 1-13 and 1-14). **Note, do not connect the winch cables to the battery at this time.**
16. The front bumper and winch installation steps are complete as shown and following steps are for the control switch installations. (See illustration 1-15).

 = T
UPPER BUMPER 8MM FASTENER TORQUE: 17 ft. lbs. (23 Nm)

 = T
LOWER BUMPER 10MM FASTENER TORQUE: 34 ft. lbs. (46 Nm)

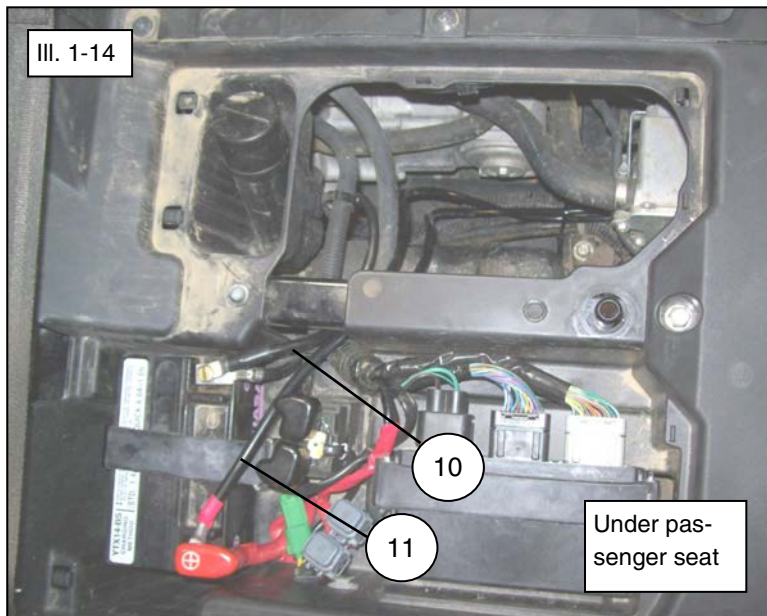
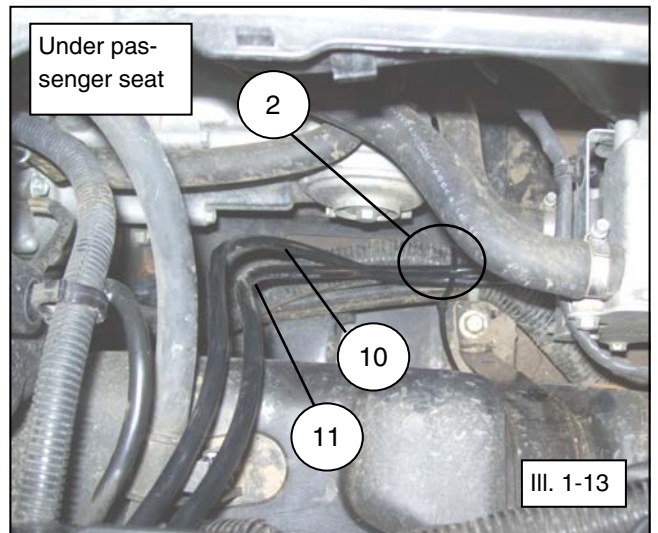
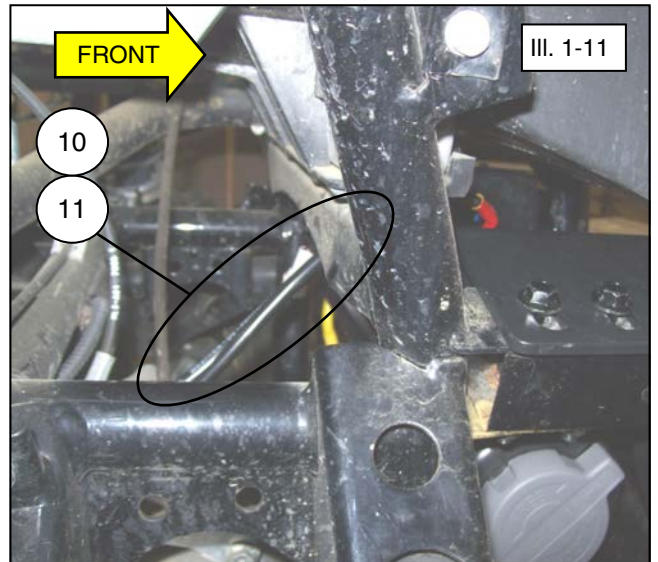
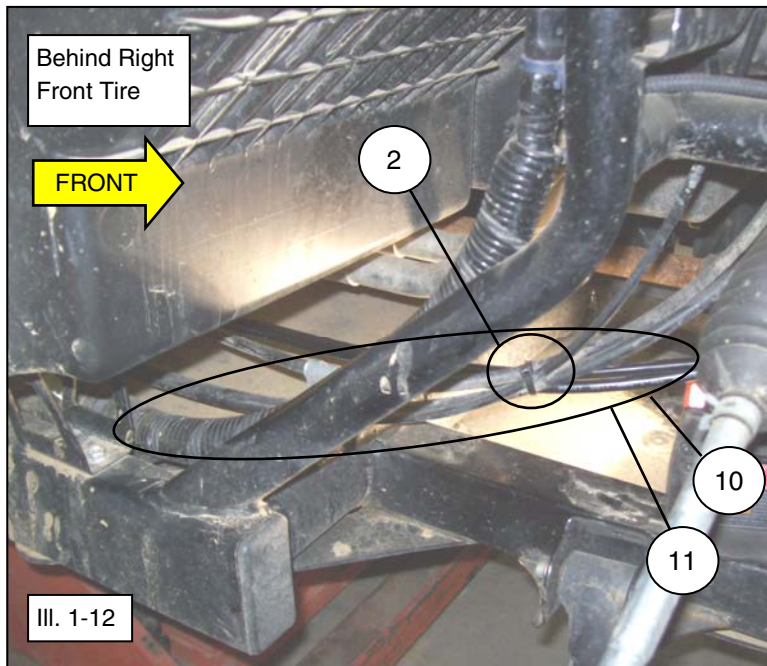

**PIONEER 700 CORDED REMOTE SWITCH
INSTALLATION:**

NOTE: See the *Electrical Connections Reference Guide* section of the instruction manual for detailed photos of each part and their respective connections.

17. From inside the cab, drill a 1" (25mm) diameter hole into the dash panel as shown (or in desired location). Use the corded remote socket harness to best locate hole position. (See illustration 1-16).
18. Position the remote socket into the drilled hole as shown. Mark the two screw holes and drill using a 5/32" (4.0mm) diameter bit. Feed the corded remote harness thru the large hole and install the dash socket (item #22) using the supplied M5 flat washers (item #25) and small screws (item #24) into the dash panel as shown. (See illustration 1-16).
19. Torque screws to the specification listed, being careful not to overtighten.

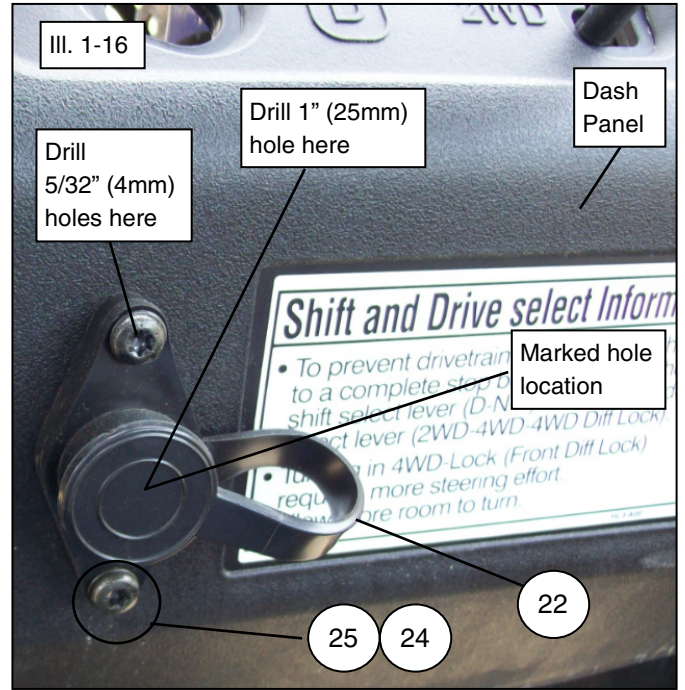

 = T
SWITCH SCREW FASTENER TORQUE:
2 ft. lbs. (2.7 Nm)

20. Route the supplied Pioneer vehicle harness (item #22) down through the firewall towards front gear case area. Continue to route the harness to the bottom of the radiator. Use cable ties (item #2) to secure the harness as shown. (See illustration 1-17).
21. Connect the white harness connector to the winch contactor connector as shown. Access is gained by reaching thru the area behind front right tire to reach white contactor connector. (See illustration 1-17).
22. From under the hood area, access the vehicle harness that connects to the accessory socket and unplug connector. Then inline connect the Pioneer Accessory Power Harness (item #20) to the accessory socket and vehicle harness as shown. (See illustration 1-18).
23. Now connect the Pioneer Accessory Power Splitter Harness (item #23) into the Corded Remote harness red lead (item #22) and Accessory Power Harness red receptacle connector (item #20). Secure and bundle the winch harnesses using plastic tie (item #2) as shown. (See illustrations 1-18 and 1-23). **Note, the power accessory splitter harness will also be used to connect to the Dash Mount switch.**

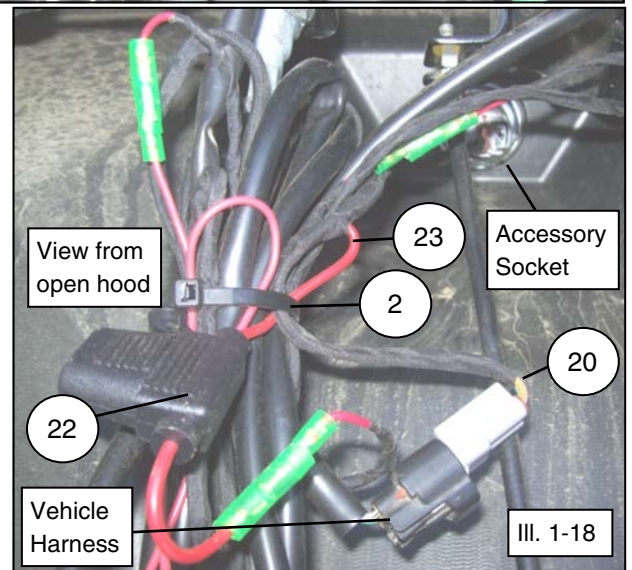
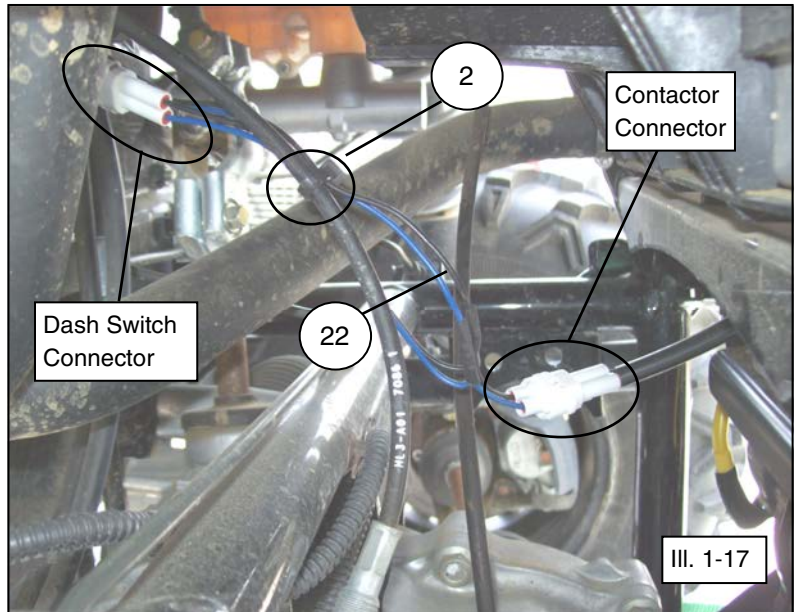

PIONEER 700 DASH MOUNT SWITCH INSTALLATION:

NOTE: See the *Electrical Connections Reference Guide* section of the instruction manual for detailed photos of each part and their respective connections.

24. Install dash mount switch (item #1) to desired location on your dash. Check to see if your vehicle has marked rectangular predefined switch location and trim area out. If not, use the cut-out dimensions shown below to cut-out the switch location in your desired location. (See illustrations 1-19 and 1-21).
25. Connect the dash mount switch (item #1) to the Pioneer Vehicle Dash Switch Harness (item #21). Connect green wire to the "Out" pin, red wire to the middle pin and black wire to the "In" pin as shown. (See illustration 1-20).
26. Insert the dash switch harness and switch assembly thru the panel hole as shown. The switch will clip into the dash panel. (See illustration 1-22).
27. From under the hood area, on firewall, connect the red lead wire from dash switch harness into the Accessory Power Splitter Harness (item #23) red wire receptacle, as mentioned in previous step 23.
28. Route the remaining length of the dash switch harness (item #21) along the Corded Remote Switch harness (item #22), previously installed in step 20. Secure with plastic ties (item #2) as shown. (See illustrations 1-17, 1-18 and 1-23).
29. Connect the dash switch white connector into the pigtail corded remote harness white connector as shown. (See illustration 1-17).

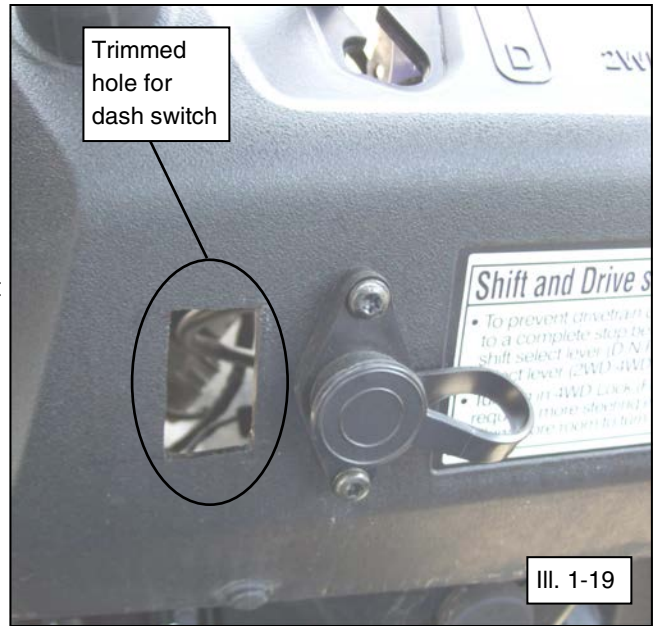

III. 1-19

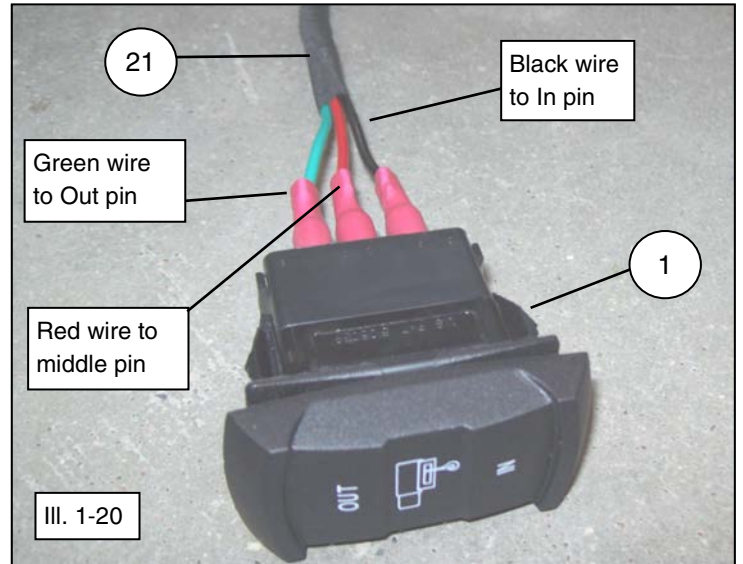

III. 1-20

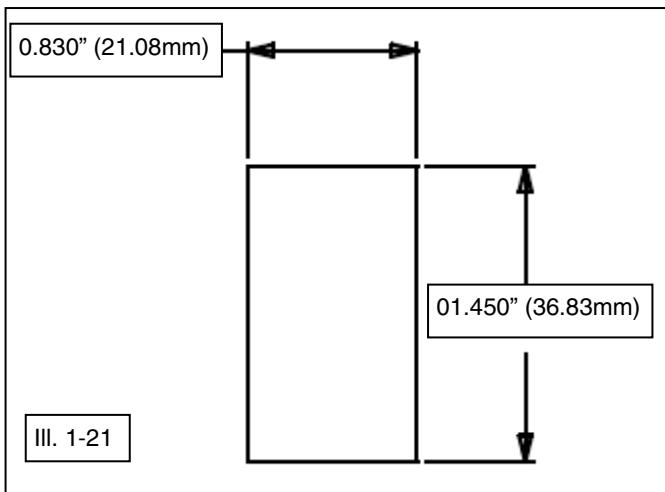

III. 1-21

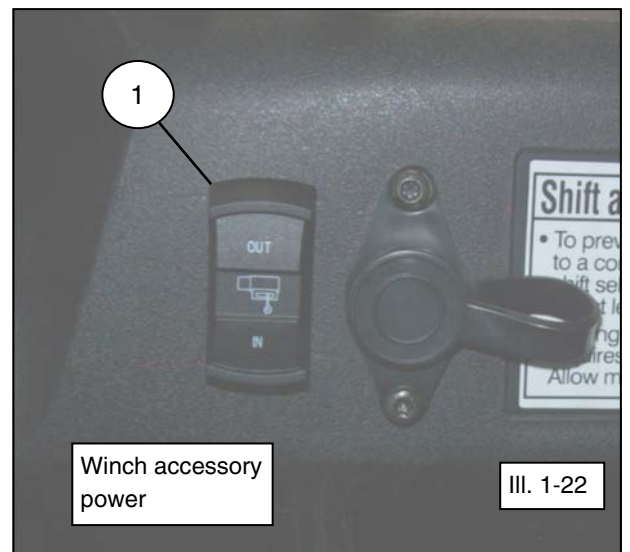

III. 1-22

PIONEER 700 FINAL INSPECTION:

30. Confirm that all wiring is correct.
31. Confirm that there are no exposed wires or terminals.
32. All loose wires need to be wrapped tight, and secured away from moving parts and heat sources.

PIONEER 700 REINSTALLATION:

33. Reconnect the main vehicle power cables and the winch power red (positive) and black (negative) cables to battery terminals at this time using original hardware.
34. Reinstall the front hood and passenger seat bottom.
35. Connect the corded winch remote switch (item #22).
36. With vehicle key in the ON position, check winch for proper operation.

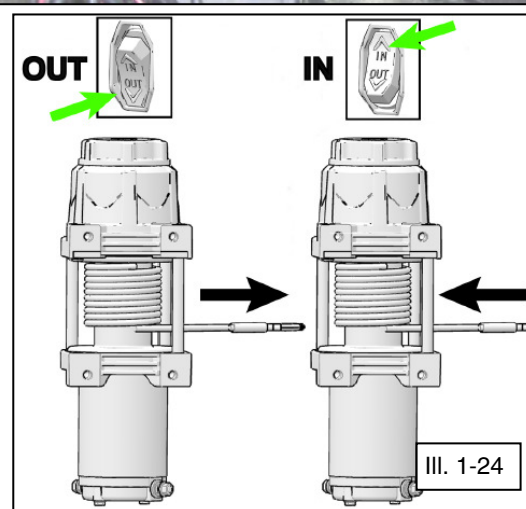
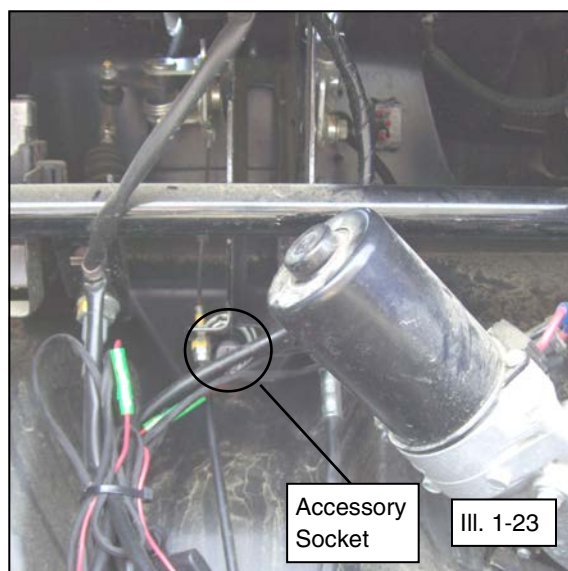

CONTROL SWITCH OPERATION:

When properly installed, the control switch(es) allow you to operate the winch while seated in the vehicle using the dash switch or remotely using the corded switch. Proper switch operation is shown. (See illustration 1-24).

For additional assistance, please contact Kolpin customer service department at (877) 956-5746 or (763) 478-5800 or email customerservice@kolpin.com

Five Year Mechanical Limited Warranty and Three Year Electrical Limited Warranty

For the period of five (5) years from the purchase date, Kolpin will replace for the original purchaser, free of charge, any mechanical part or mechanical parts found upon examination by Kolpin to be defective in material, workmanship, or both. For the period of three (3) years from the purchase date, Kolpin will replace for the original purchaser, free of charge, any electrical part or electrical parts found upon examination by Kolpin to be defective in material, workmanship, or both.

All transportation costs incurred submitting product to Kolpin for warranty consideration must be borne by the purchaser. If Kolpin determines that the product must be returned to the factory for credit, please call 1-877-956-5746 for a Return Merchandise Authorization (RMA) number and shipping instructions.

This warranty does not apply to parts that have been damaged by accident, alteration, abuse, improper maintenance, normal wear, or other causes beyond the manufacturer's control. In order to protect you and your ATV, certain parts of the winch/plow system and/or hardware are designed to fail when the equipment is over-stressed. Parts that are lost due to loosening and improper maintenance are not covered under warranty. This warranty does not cover removal or reinstallation labor fees of the winch/plow system and related components.

Peripheral products such as engines, electric motors, and actuators may carry an original manufacturer's warranty. Most hardware is general in nature and is easily obtained locally. Be sure to replace with minimum metric class 8.8 specification.

Kolpin Outdoors, Inc.

www.kolpin.com

TROUBLESHOOTING

If your winch is not functioning properly, below is a short guide that can help you diagnose and correct the problem.

Symptom	Possible Causes	Recommended Solution
Winch will not operate	Contactors not receiving power	Turn vehicle key on.
	Connections between components not in proper order	Check connections. Connect wired handlebar switch connection from vehicle main wire harness directly to contactor to make sure a direct connection will operate the winch. If connections are not in the order shown in the pictures in the last page, the whole system may not function or only certain parts of it will function.
	Loose battery cable connections	Tighten nuts on all cable connections.
	Keyed power circuit (orange wires) not properly powered	Check fusebox for 10A accessory circuit. Check voltage in certain places, especially orange wires coming out of the main harness by the steering post.
	Contactors malfunctioning	Tap contactor to loosen contacts. Apply 12 volts to coil terminals directly. A clicking indicates proper activation.
	Defective switch assembly	Replace switch assembly.
	Defective motor	Check for voltage at armature port with switch pressed. If voltage is present, replace winch assembly.
	Nested and bounded cable within winch assembly	Move free spool knob to the "free spool" position. Manually pull cable out of winch until end is met and then re-spool cable back into winch.
Winch makes noise but rope does not move	Water has entered motor	Allow to drain and dry. Run in short bursts without load until completely dry.
	Contactors powered, but not winch	If you can hear a clicking sound when you press the winch control but the winch does not make any sounds, check the connections between the winch and the contactor.
Winch operates too slowly	Winch not in proper gear	Move free spool knob to the "locked spool" position, then recheck. If problem persists, a qualified technician needs to check and repair.
	Winch improperly loaded	Check that the winch is clear and the rope is not bound up and that there is no load pulling on the rope.
	Insufficient current or voltage	The battery is weak, recharge. Run winch with vehicle motor running (battery should have a strong charge).
Winch overheating	Loose or corroded battery cable connections	Clean, tighten, or replace.
	Winch running time too long	Allow winch to cool down periodically.
Winch operates in one direction only	Defective or stuck contactor	Tap contactor to loosen contacts.
		Repair or replace contactor.
	Defective switch assembly	Replace switch assembly.
	Defective brake assembly	Replace winch assembly.

Note: If any hardware is missing, do not return to the store. Call us to help, Toll Free 1-877-956-5746.

NOTE

For further technical support, contact our help line at 1-877-956-5746.

ELECTRICAL CONNECTION REFERENCE GUIDE:

Pioneer 700:

Winch with Roller Fairlead, Dash Switch and Corded Remote Switch

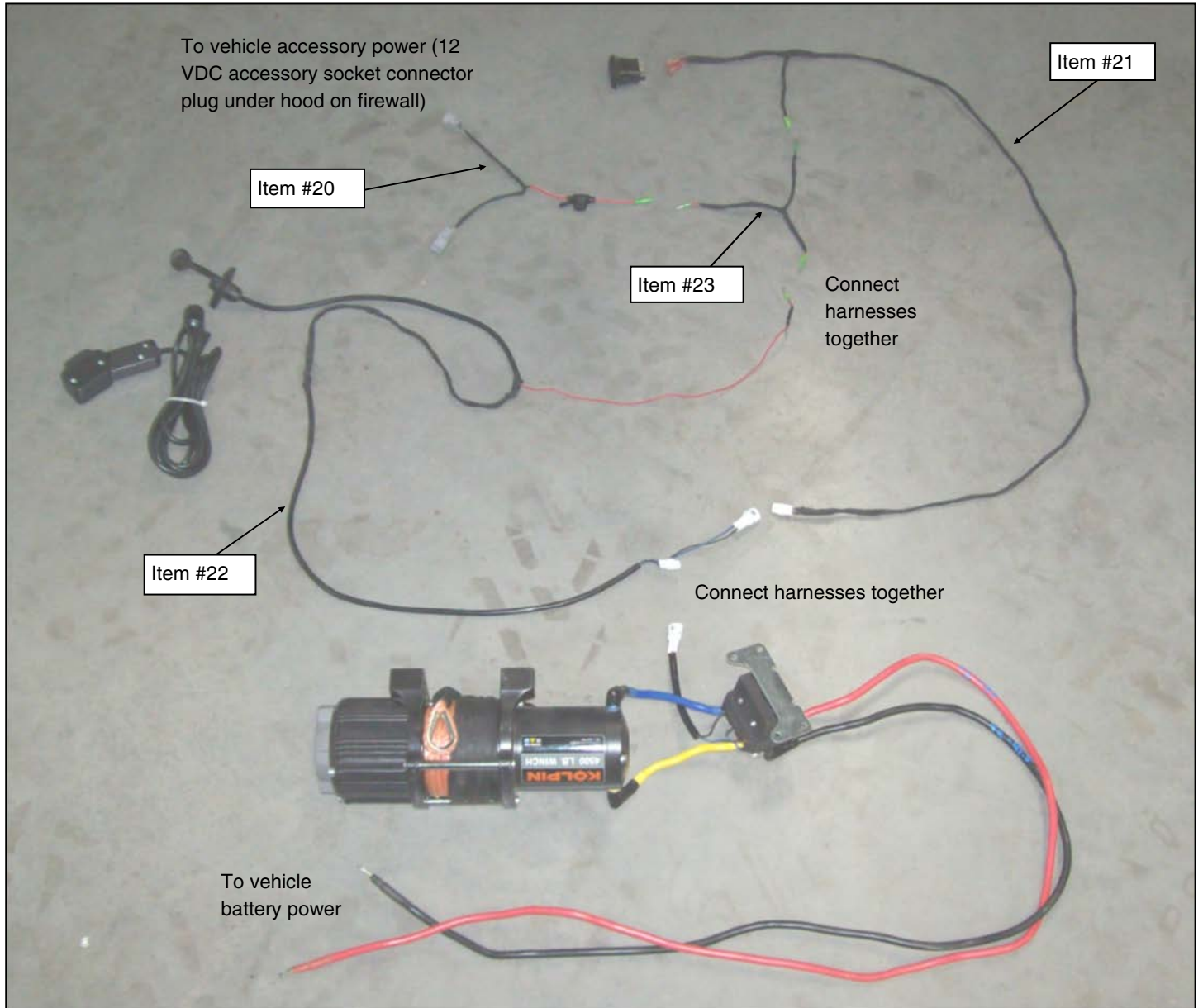

ELECTRICAL CONNECTION REFERENCE GUIDE (continued):

Pioneer 700:

Winch with Roller Fairlead and Dash Switch

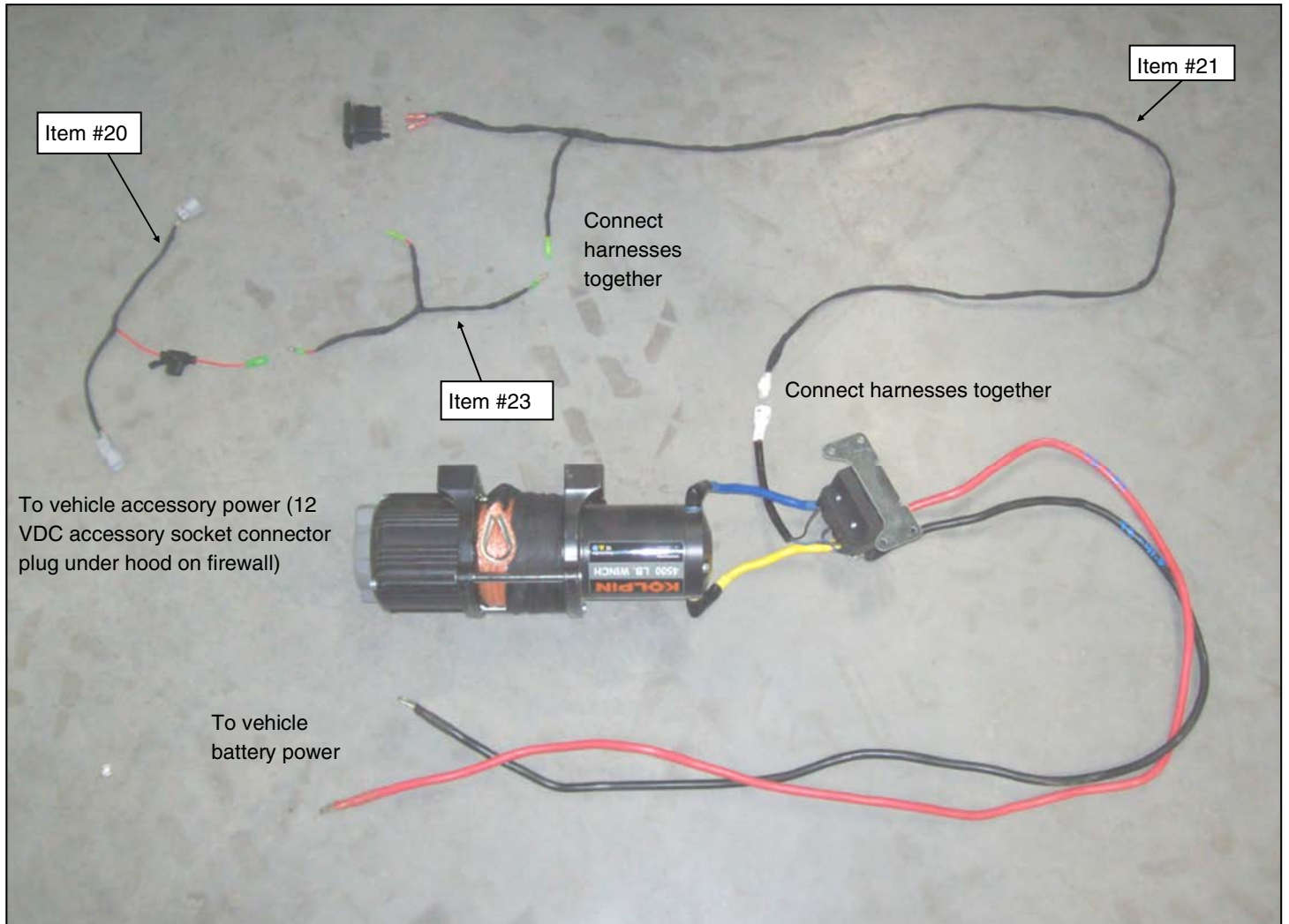

ELECTRICAL CONNECTION REFERENCE GUIDE (continued):

Pioneer 700:

Winch with Roller Fairlead and Corded Remote Switch

