



WINCH MOUNT KIT

FOR HONDA TALON 1000

P/N 25-1300

ASSEMBLY / OWNERS MANUAL

Application

WINCH KIT NO. 25-9xxx

Before you begin, please read these instructions and check to be sure all parts and tools are accounted for. The following instructions contain details required to install and service the contents of this kit.

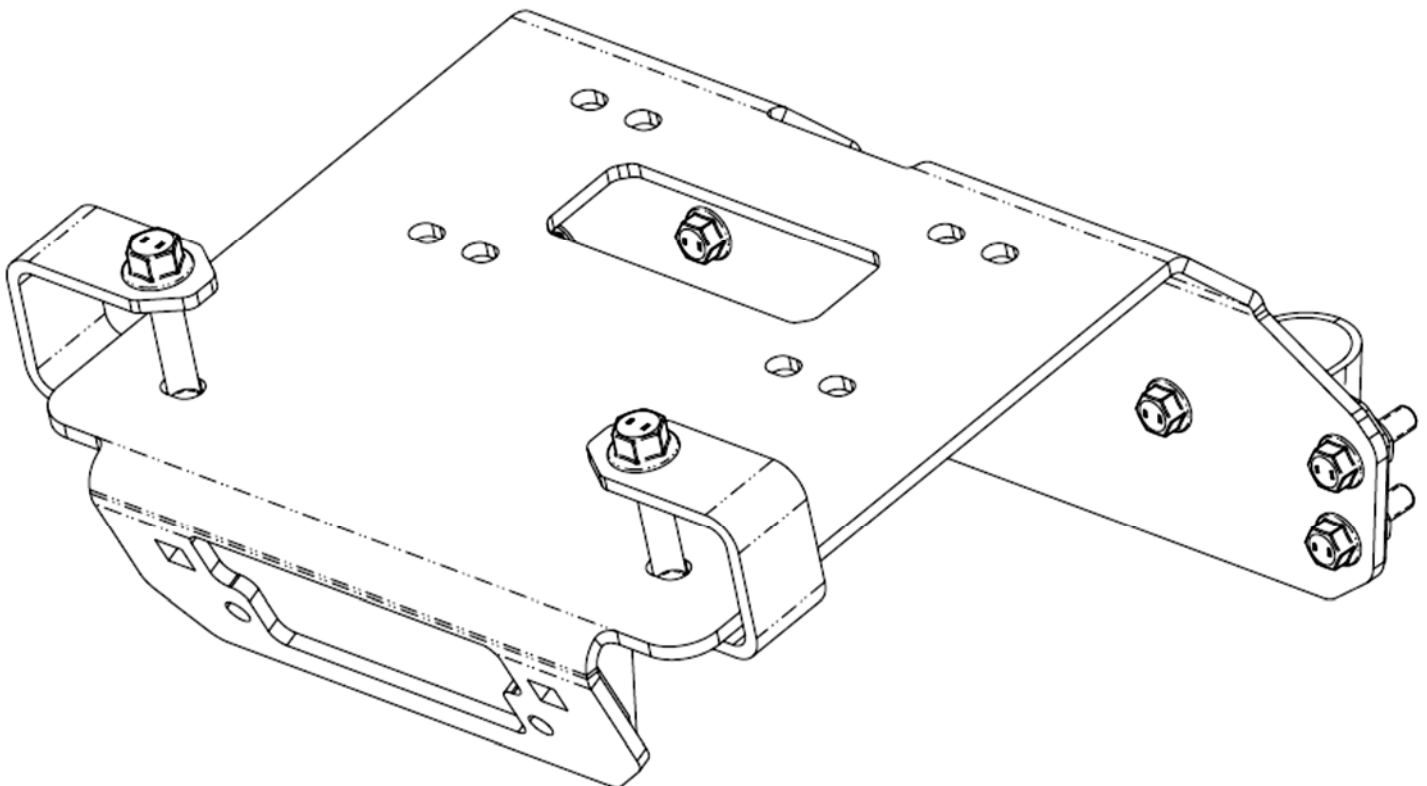

OPERATING INSTRUCTIONS

Congratulations! You've just purchased the most durable accessory component in the industry. Our accessories work great all year round! With proper care and maintenance, your Kolpin accessory will last for years to come! Please read and understand all assembly instructions, notices and warnings before assembling and using your Kolpin accessory.

Follow these guidelines to ensure a successful and satisfactory installation:

Read, understand this manual before beginning installation

Periodically check for wear and tightness of all fasteners.

Replace or re-torque fasteners as necessary.

SAFETY & GENERAL PRODUCT INFORMATION

Kolpin accessories are designed with your safety in mind.

In order to protect you and your vehicle, certain parts of the accessory and/or hardware may be designed to collapse or break when the equipment is over-stressed.

Kolpin winch mount kits are designed to be compatible with Kolpin and Cycle Country winches along with many others, but may not be compatible with some winches. Kolpin winch mount kits have design features that benefit snow plow applications.



! DANGER ! ! WARNING ! ! CAUTION !

To avoid personal injury or damage to your vehicle:

Read and understand all notices for:

Caution

Warning

Danger

Follow instructions for your vehicle, winch, winch mount and other items used in combination with this product.

Do not winch unsecured loads at any time.

Disconnect battery during winch installation or service to prevent electrical hazards.

Do not lift loads overhead.

Do not exceed the load capacity of the winch.

Always wear gloves when handling wire winch cable.

Do not use your winch or winch mount for towing.

Do not shock load the winch, cable or winch mount.

Keep fingers, hands and loose clothing away from roller fairlead and winch cable drum when in use.

Kit Contents:

Item	Qty	Part Description	Part Number
1	1	Winch Mount Plate	-
2	2	Bumper Clamping U-Bracket	-
3	2	Hex Flange Locknut, Zinc Plated, M10-1.5	-
4	2	Hex Flange Screw, Zinc Plated, M10-1.5 x 75mm LG	-
5	2	Frame Clamp, Painted, M8-1.25	-
6	6	Lock Washer, Zinc Plated, M8	-
7	6	Flat Fender Washer, Zinc Plated, M8	-
8	6	Hex Flange Screw, Zinc Plated, M8-1.25 x 30mm LG	-
9	1	Instruction Guide (not shown)	-

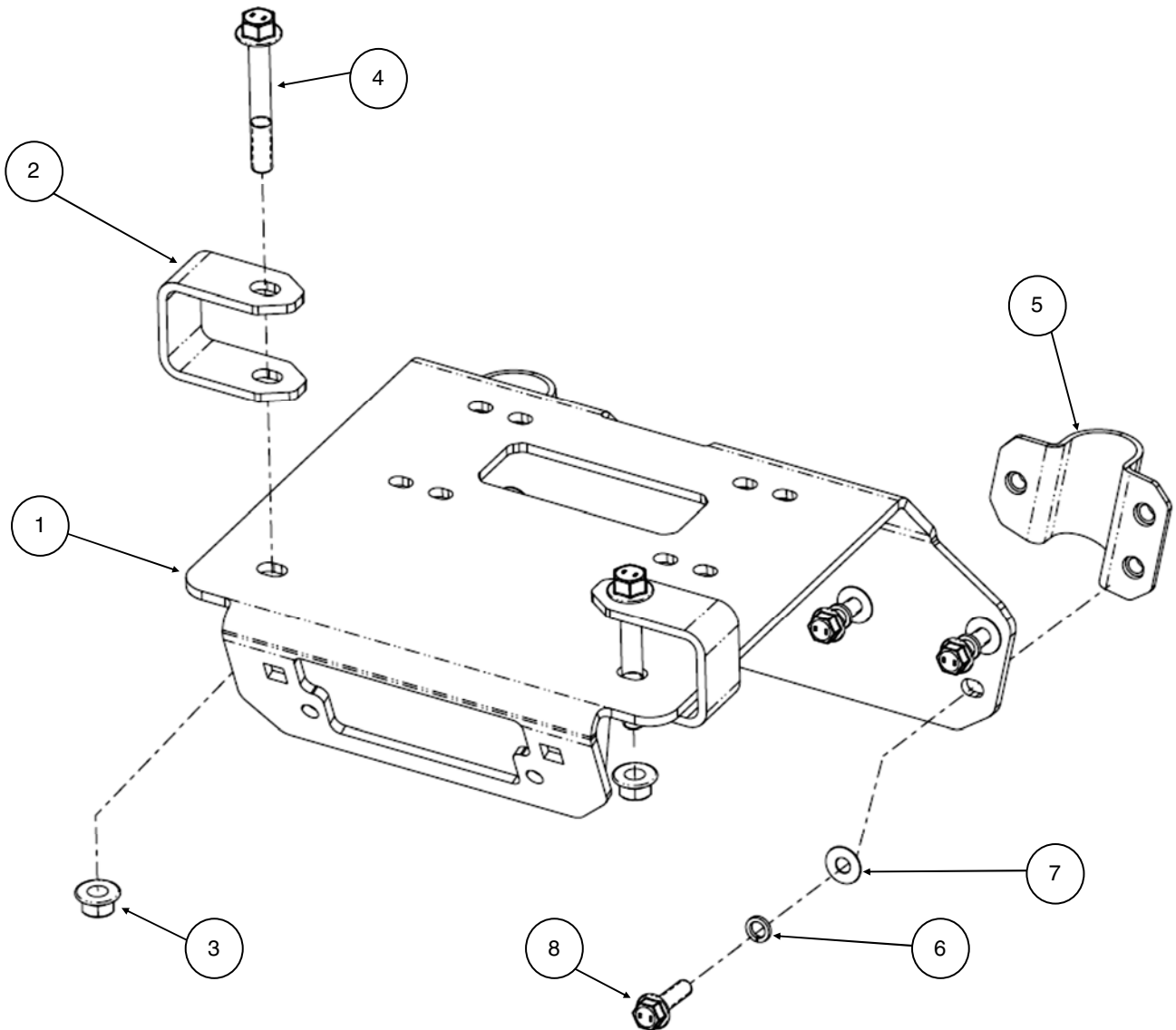

BEFORE YOU BEGIN:

- Your Kolpin accessory is exclusively designed for your vehicle
- Please read and understand all instructions
- Verify all parts and tools are accounted for
- To ensure a satisfactory installation, follow all steps correctly and in the sequence described
- Keep these instructions for future reference or for informational requests
- To facilitate installation, make sure that your vehicle is clean and free of debris
- All directions referring to right and left are when the rider is sitting on the machine

TOOLS REQUIRED:

- Metric Wrench set
- Metric Socket set
- Pliers
- Metric Hex Allen Key Wrench or Socket set
- Do not use impact tools to install hardware

APPROXIMATE ASSEMBLY TIME: 30 minutes

Note: If any hardware is missing, do not return to the store. Call us to help, Toll Free 1-877-956-5746.

TALON 1000 PREPARATION:

1. Shift vehicle transmission into "PARK". Turn key to "OFF" position and remove from vehicle.
2. To gain access to electrical connections, turn the hood knobs, pull upwards to release tabbed grommet holds and remove hood as shown. (See illustration 1-1).
3. Locate the battery box, release clips and remove cover. Disconnect black (negative) and red (positive) cables from battery. (See illustration 1-2).

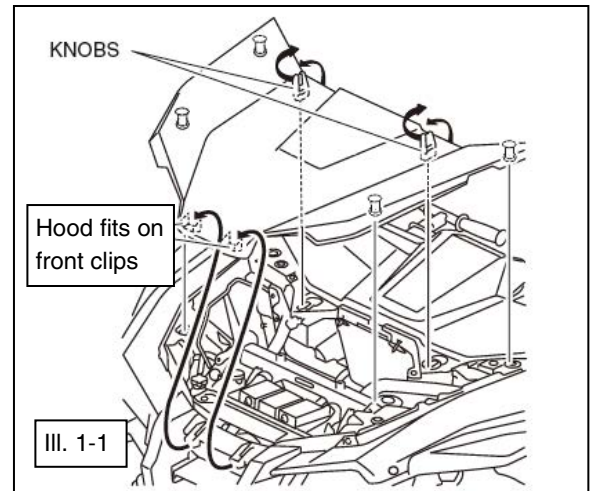

⚠ WARNING ⚠

ALWAYS disconnect black negative (-) cable from battery **FIRST**. Failure to do so will result in high current electrical arc, and may result in battery explosion if tool touches grounded frame. Death or serious injury may occur.

4. Remove the bumper screws from each side and front bumper as shown. Save all for re-install later. (See illustrations 1-3 and 1-4). **Note, the 5mm, 6mm and 10mm bolts will be re-used for bumper installation later. This winch mount kit can be used with the stock bumper and Honda Signature Accessory Front Bumper (see illustration 1-14).**

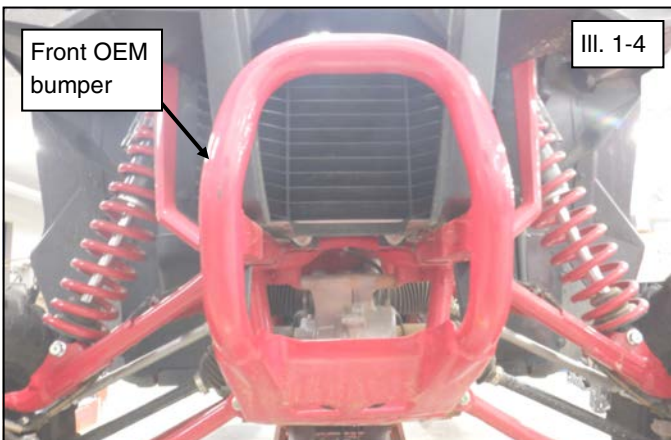
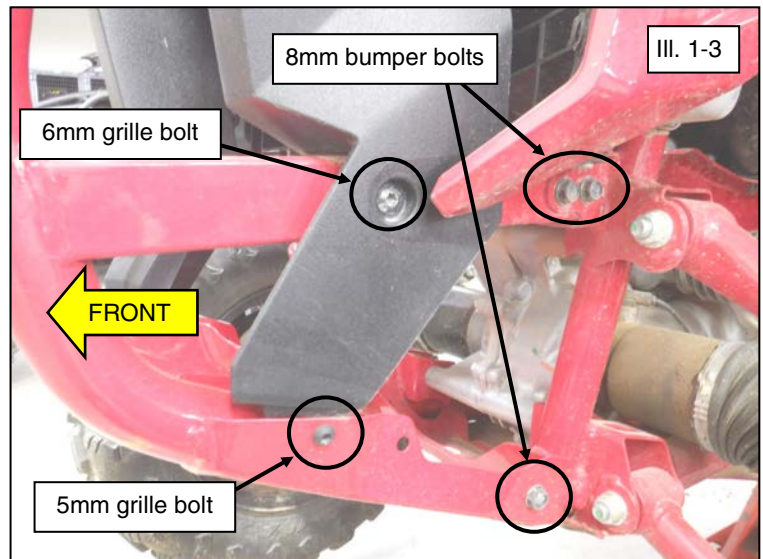
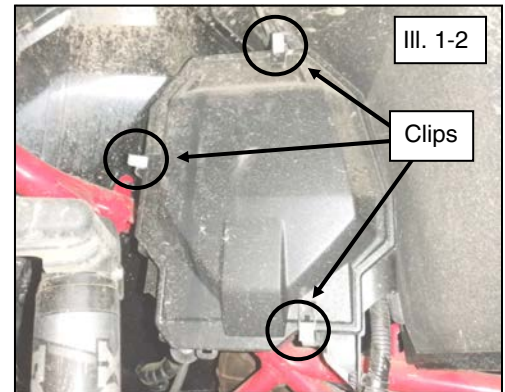

TALON 1000 WINCH INSTALLATION:

- Using the hardware provided with winch kit, attach the winch and roller fairlead to the mounting bracket (item #1) as shown. (See illustration 1-5). **Note, roller fairlead is included with winch kit, not mounting plate kit.**
- Position the winch sub-assembly into the front bumper as shown. (See illustration 1-6).
- Assemble the mounting bracket to the front bumper using the U- Bracket Clamps (item #2) and two M10 long bolts (item #4). Place the U-Bracket over the bumper frame tube as shown. Insert the bolts thru the winch bracket and U - Bracket and then fasten from bottom using two M10 locknut (item #3). (See illustrations 1-7, 1-8 and 1-9). **Note, do not tighten hardware at this time.**

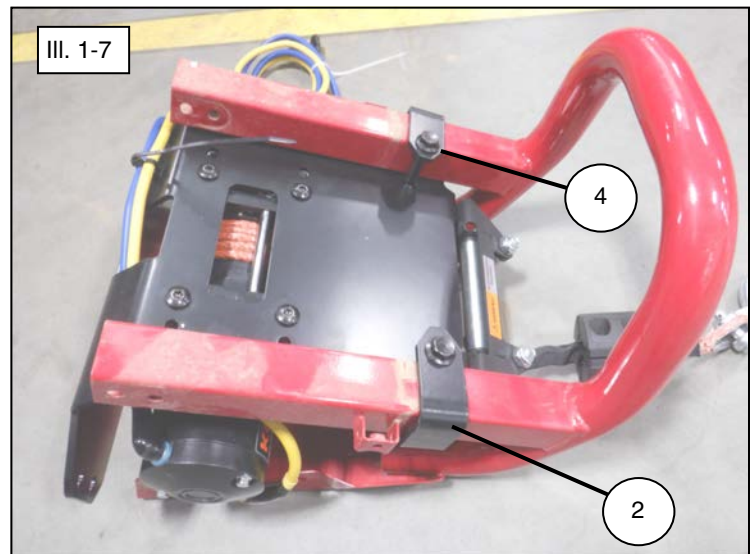
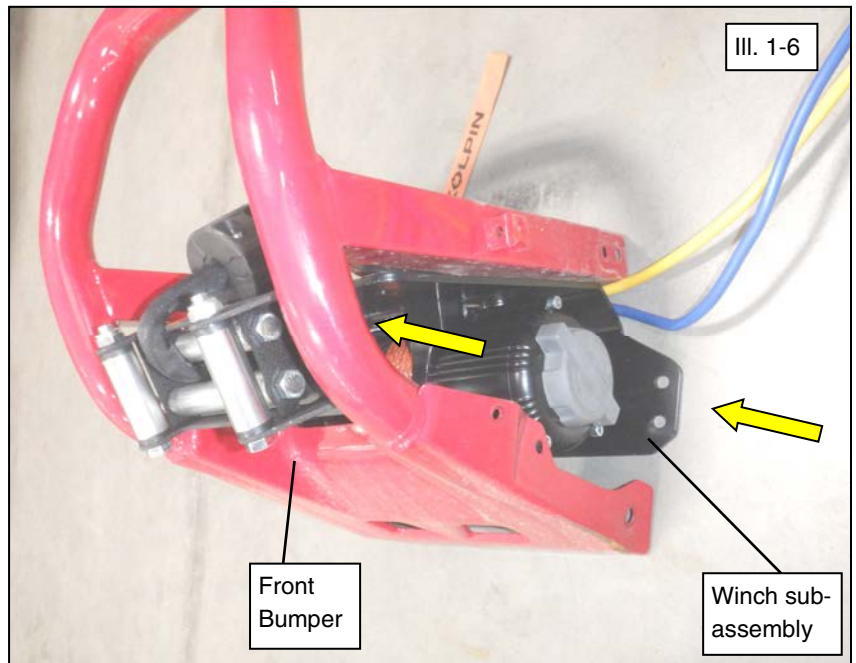
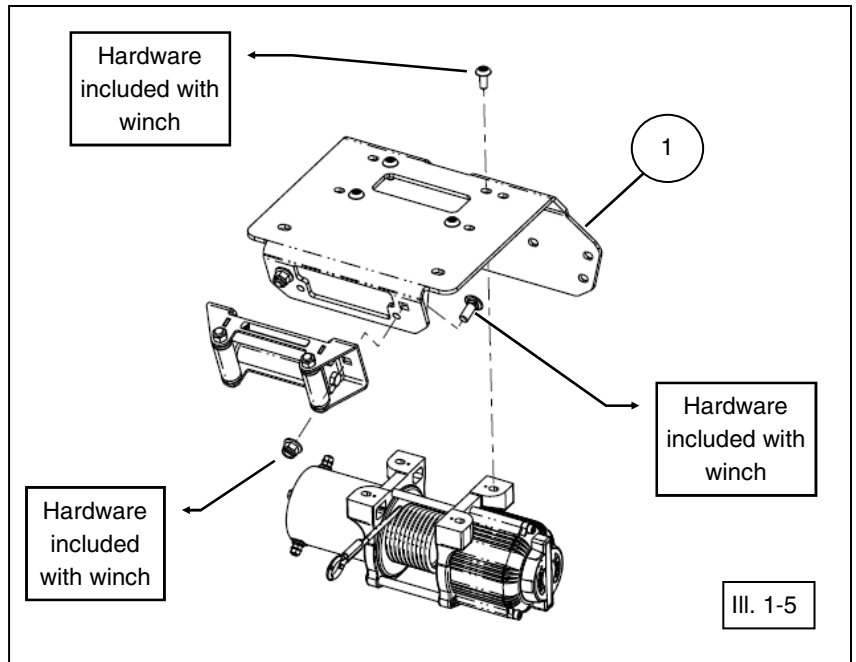

TALON 1000 WINCH INSTALLATION (continued):

8. Install winch-bumper assembly onto the frame re-using the OEM hardware removed in step 4 as shown. (See illustrations 1-9 and 1-10). **Note, do not tighten hardware at this time.**

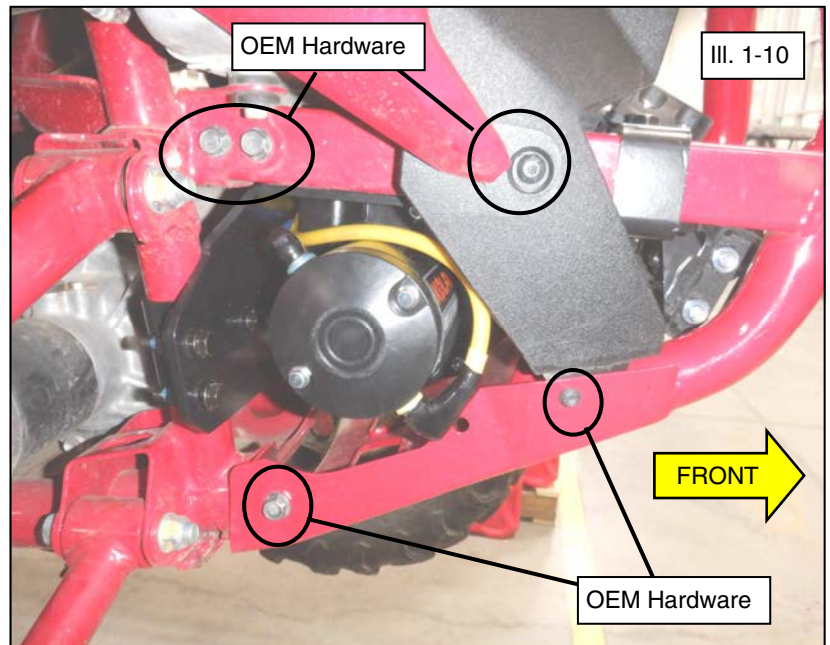
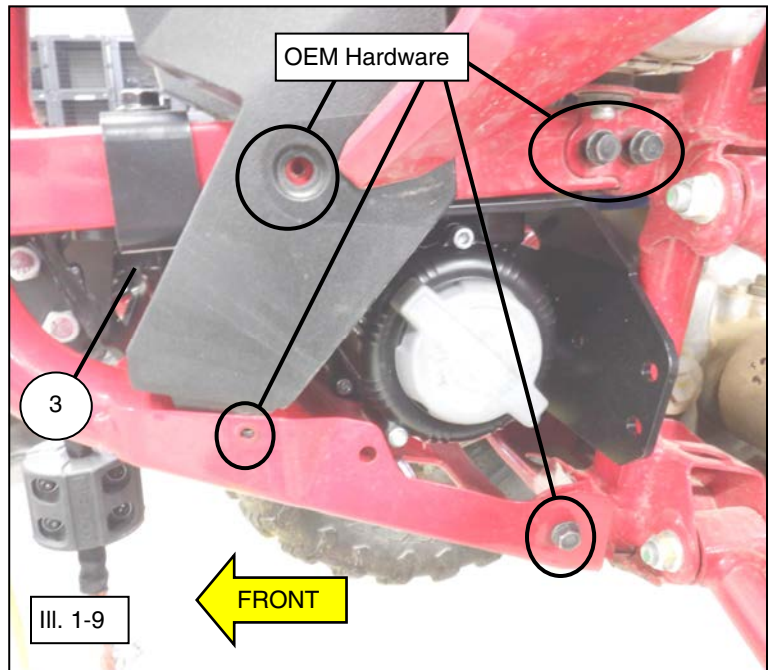
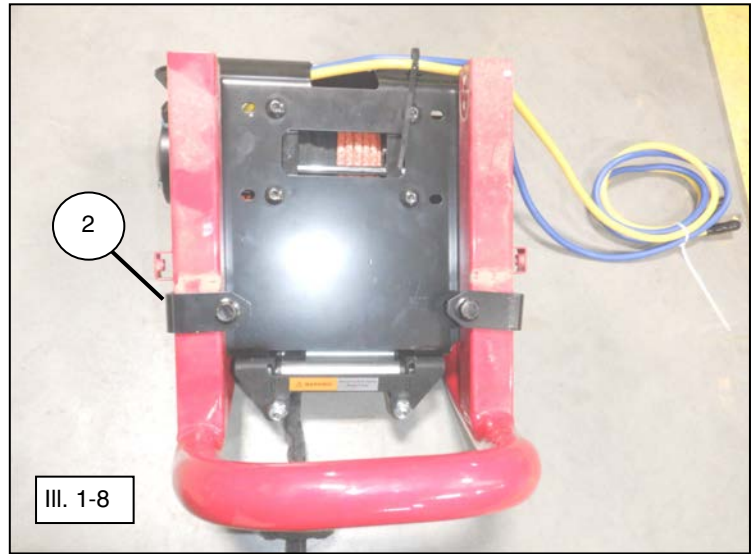

TALON 1000 WINCH INSTALLATION (continued):

9. Install the Frame Clamps (item #5) onto the back side of the vertical frame tubes, lining up with winch mount plate (item #1) as shown. Fasten the clamps by inserting M8 screws (item #8), M8 lock washers (item #6) and M8 flat washers (item #7) through the winch mount plate holes. (See illustrations 1-10, 1-11 and 1-12). **Note, do not tighten hardware at this time.**
10. Tighten the OEM bumper hardware to specifications listed below: four M8 upper bumper screws, two M8 lower bumper screws, two M6 upper plastic grille screws and two M5 lower plastic grille screws.

 = T
BUMPER 8MM FASTENER TORQUE: 17 ft. lbs. (23 Nm)

 = T
PLASTIC GRILLE 6MM FASTENER TORQUE: 7 ft. lbs. (9.5 Nm)

 = T
PLASTIC GRILLE 5MM FASTENER TORQUE: 4 ft. lbs. (5.5 Nm)

11. Tighten the Winch Mount M10 and M8 hardware as specified below. (See illustration 1-13).

 = T
10MM FASTENER TORQUE: 34 ft. lbs. (46 Nm)

 = T
8MM FASTENER TORQUE: 17 ft. lbs. (23 Nm)

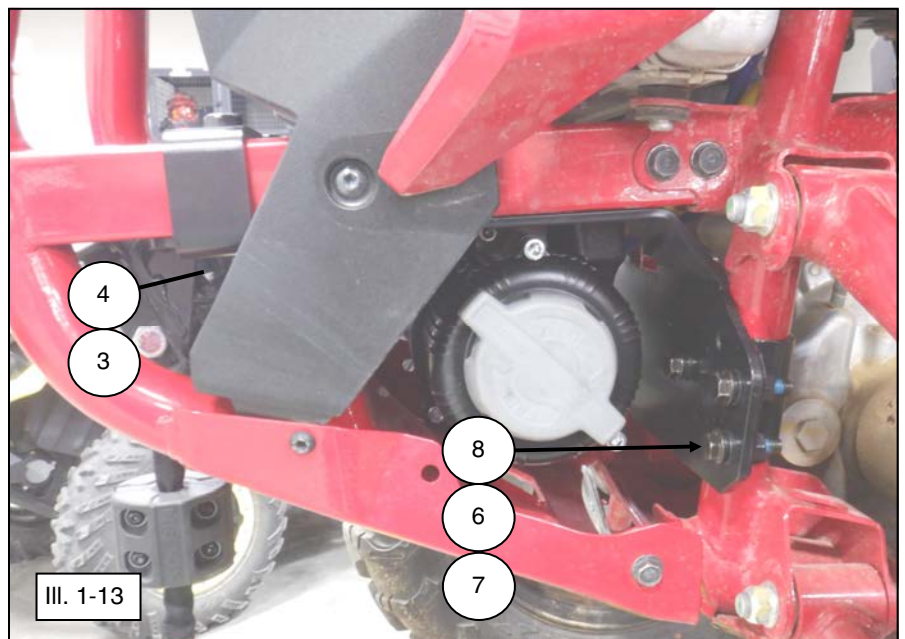
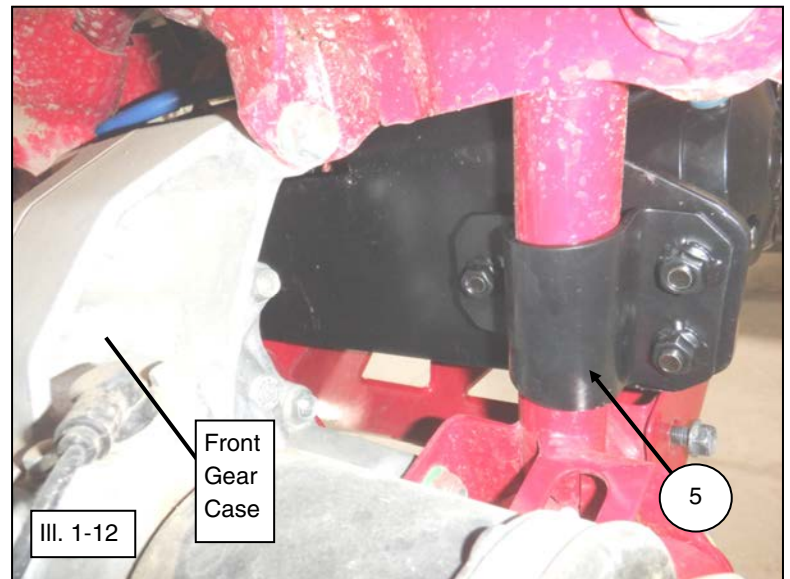
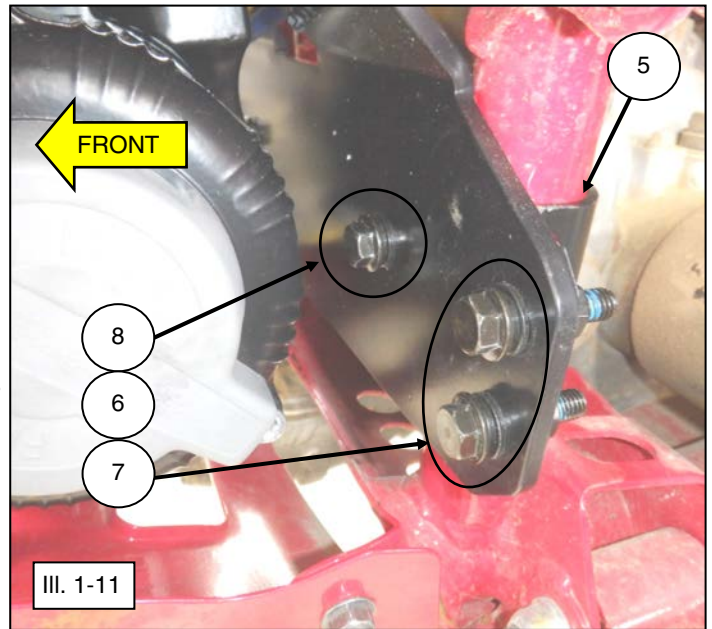

WINCH CABLE WRAP INSTALLATION ON SPOOL DRUM:

12. The winch cable or rope should be wrapped around spool drum, feeding from top, as shown. Spooling the cable as shown will prolong cable life and enhance winch performance. (See illustration 1-15).
13. Connect the hook to cable or rope by using hardware included in winch kit.

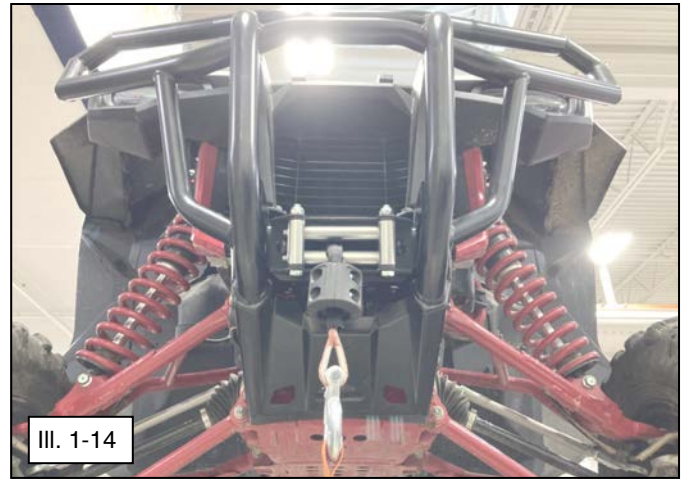

WINCH WIRING AND CONNECTIONS:

14. Using the winch kit instructions, route and connect the electrical cables and components for the winch system. Check that all wires are free to move and not pinched between the vehicle chassis and the winch-bumper assembly. **Note, the Talon vehicle is pre-wired with red and black power cables from battery to front contactor location.**
15. To gain access to install Contactor (included with winch kit), remove the rear hood by removing hex socket screws, flange screws and plastic trim clips. The blue and yellow power cables (included with winch kit) can be pulled up behind the radiator. (See illustration 1-16). **Note, the rubber splash shield can remain in place, but can be folded down for cable routing access.**
16. Locate the black and red power cables secured to the instrument panel at the location shown. Remove the blue protective tape from the terminals. (See illustration 1-17).

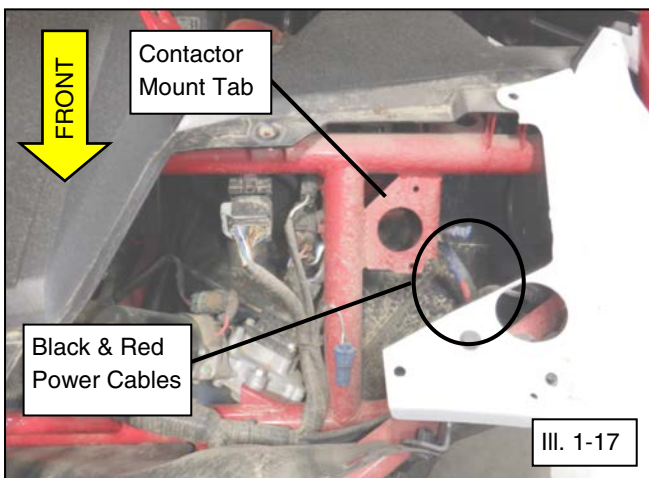
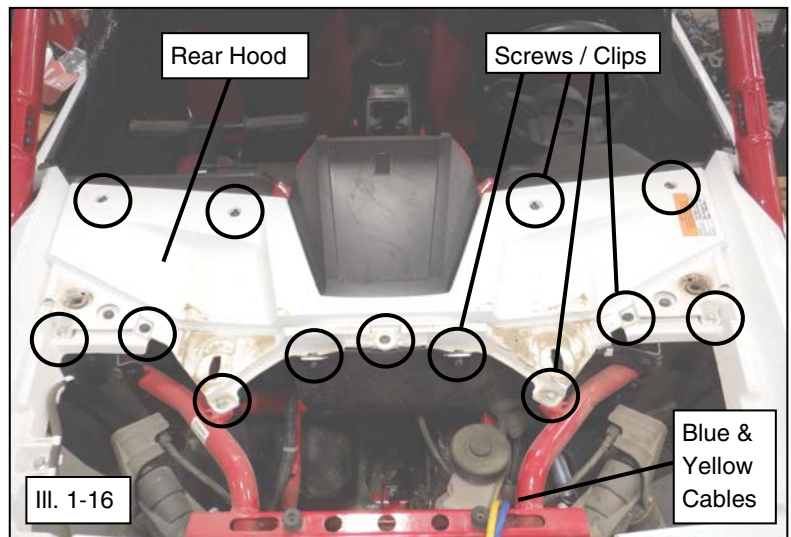

WINCH WIRING AND CONNECTIONS (continued):

16. Install a black rubber insulated terminal boot over the end of the black and red power cables as shown. (See illustration 1-18).
17. Install the contactor to the frame tab as shown using two M6 screws (item #16) and fasten using hardware supplied with winch kit. (See illustrations 1-19 and 1-20). **Note, do not connect the winch cables to the battery at this time.**
18. Install the black and red power cables to the corresponding colored contactor terminals with the provided M6 nut as shown. (See illustrations 1-19 and 1-20). **Note, the insulated black rubber boot terminals are not shown for clarity. Make sure to install the rubber boots onto the cable terminals for contactor stud terminals. Do not tighten M6 contactor nuts at this time.**

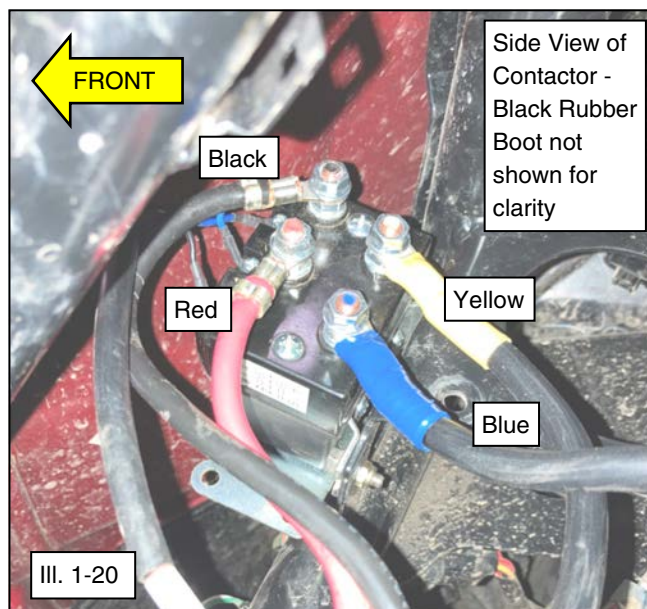
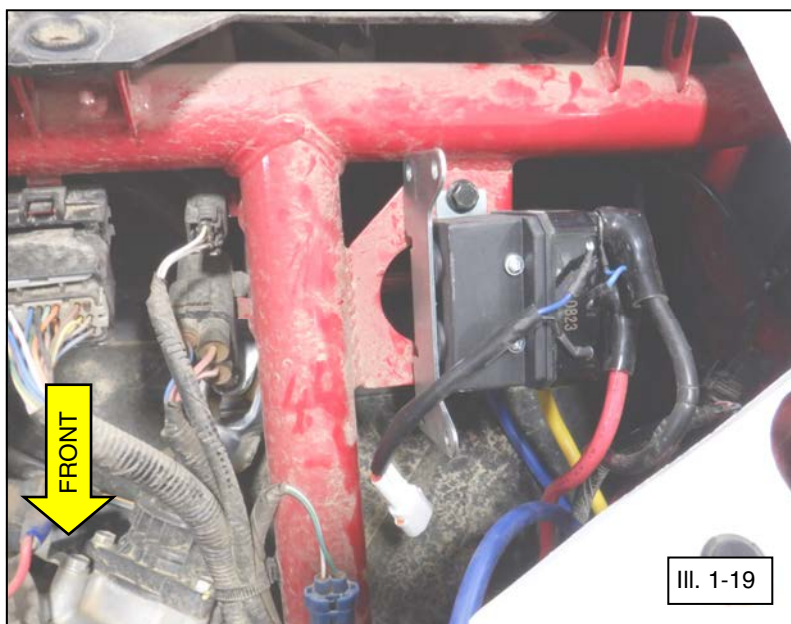
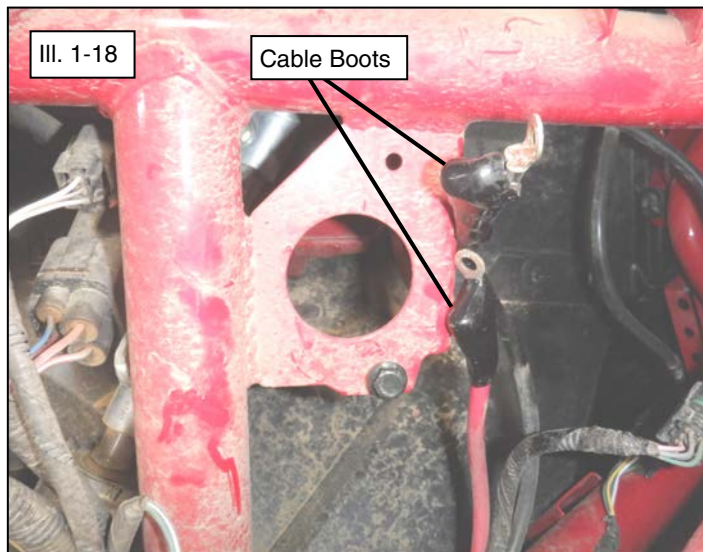

WINCH WIRING AND CONNECTIONS

(continued):

19. Route the blue and yellow power cables along frame tubes, behind radiator, over front left shock, as shown to contactor location. Secure the wires using plastic cable ties (supplied with winch kit) to the frame tubes at the four locations shown. (See illustrations 1-21, 1-22, 1-23 and 1-24).
20. Install the blue and yellow power cables to the corresponding colored contactor terminals with the provided M6 nut as shown. (See illustrations 1-19 and 1-20).
21. Tighten the M6 Contactor nuts to below specifications.

 = T
6MM CONTACTOR NUT FASTENER TORQUE: 3 ft. lbs. (4.0 Nm)

22. Slide the insulated rubber terminal boots over the four contactor stud terminals. (See illustration 1-19).

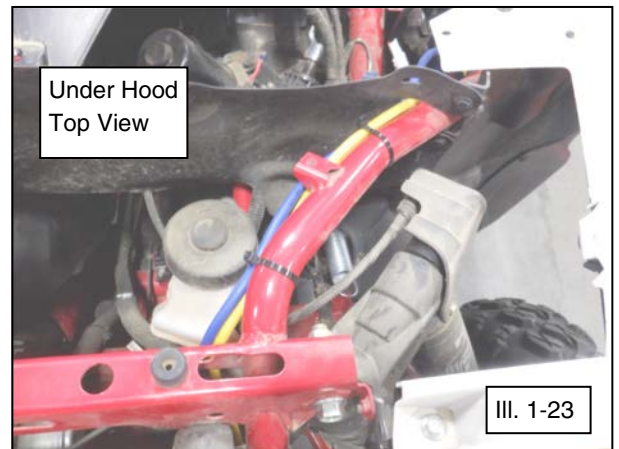
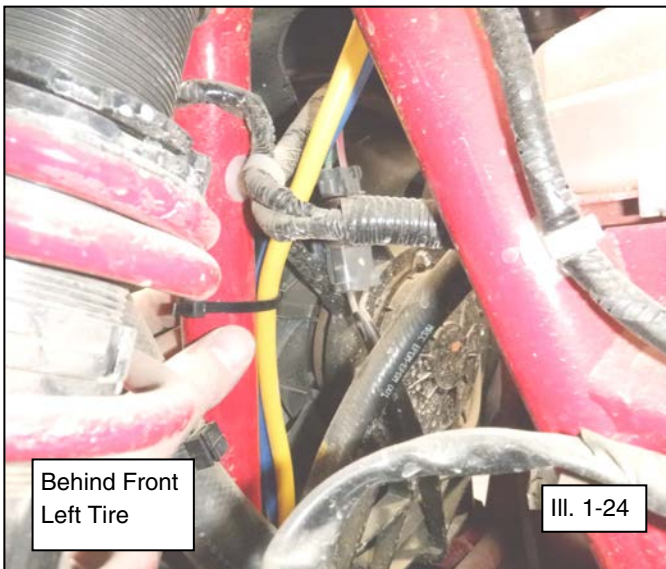
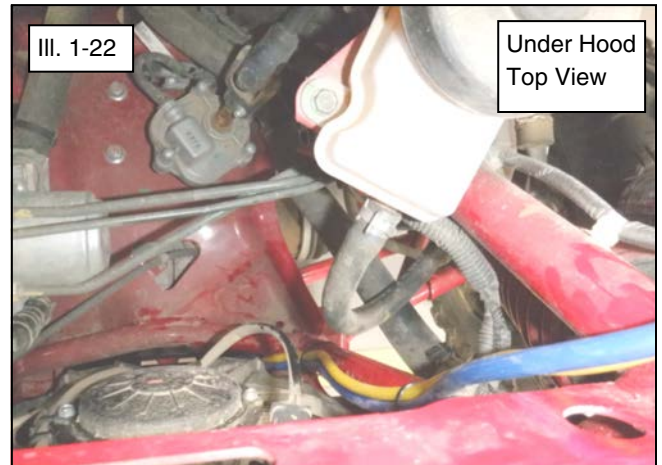
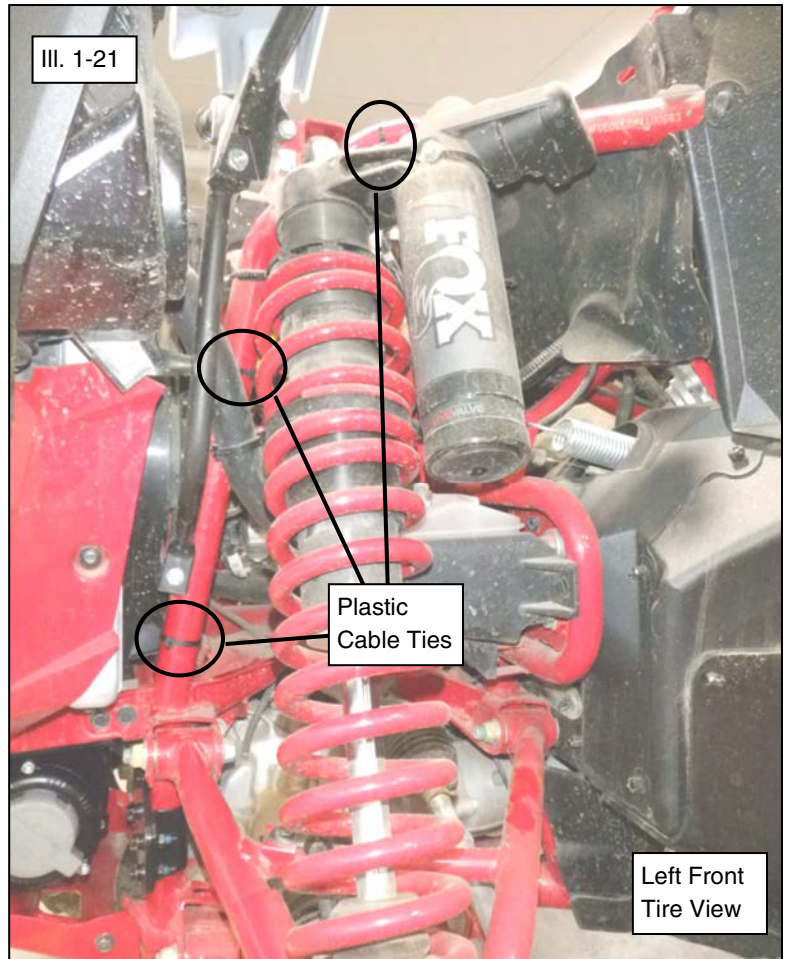

WINCH WIRING AND CONNECTIONS (continued):

23. From the battery box location, find the Red Power Wire with the angled battery terminal. The red wire is behind the gray relays. Remove the blue protective tape from red wire terminal. (See illustrations 1-25 and 1-26). **Note, the starter relay can be removed by sliding the rubber strap off the battery box plastic standoff tab.**
24. Remove the left starter relay terminal boot and connect the red wire to starter terminal as shown. (See illustration 1-27).
25. Reinstall terminal boot and return rubber relay strap to the battery box plastic standoff tabs.
26. Confirm that all wiring is correct.
27. Confirm that there are no exposed wires or terminals.
28. All loose wires need to be wrapped tight, and secured away from moving parts and heat sources.
29. Reconnect the main vehicle power cables and the winch power red (positive) and black (negative) cables to battery terminals at this time using original hardware.
30. Reinstall the rear hood, front hood and battery box cover.
31. With vehicle key in the ON position, check winch for proper operation.

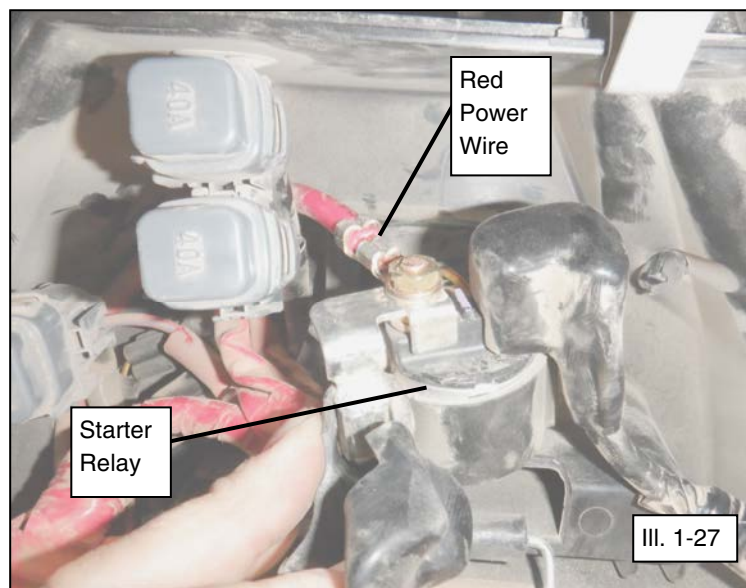
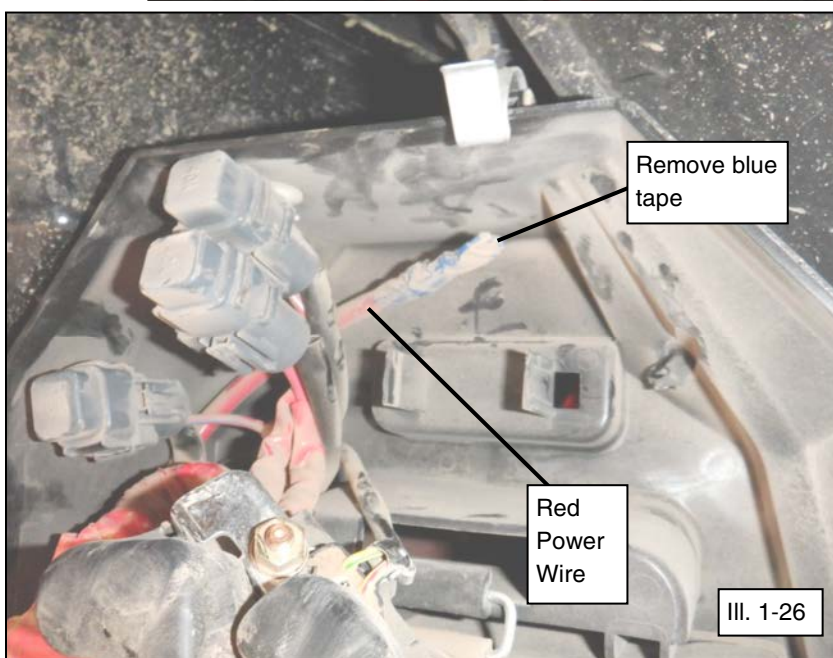
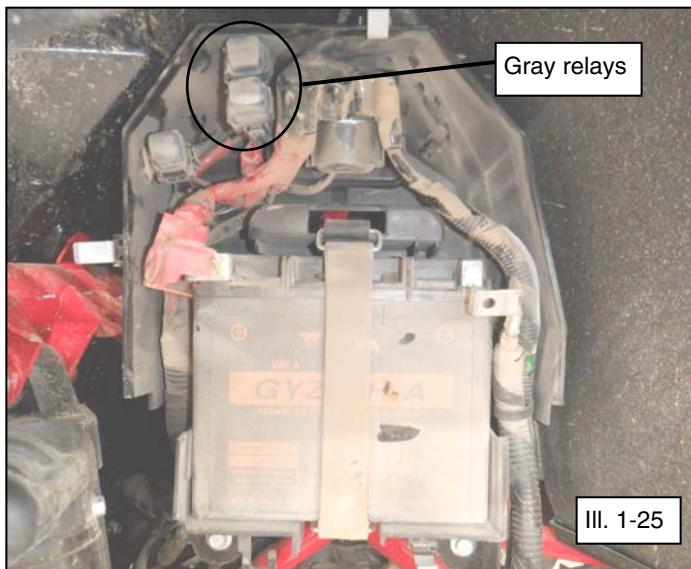



One Year Limited Warranty

For the period of one (1) year from the purchase date, Kolpin will replace for the original purchaser, free of charge, any part or parts found upon examination by Kolpin to be defective in material, workmanship, or both.

All transportation costs incurred submitting product to Kolpin for warranty consideration must be borne by the purchaser. If Kolpin determines that the product must be returned to the factory for credit, please call 1-877-956-5746 for a Return Merchandise Authorization (RMA) number and shipping instructions.

This warranty does not apply to parts that have been damaged by accident, alteration, abuse, improper maintenance, normal wear, or other causes beyond the manufacturer's control. In order to protect you and your ATV, certain parts of the system and/or hardware are designed to fail when the equipment is over-stressed. Parts that are lost due to loosening and improper maintenance are not covered under warranty. This warranty does not cover removal or reinstallation labor fees of the plow system and related components.

Peripheral products such as engines, electric motors, and actuators may carry an original manufacturer's warranty. Most hardware is general in nature and is easily obtained locally. Be sure to replace with minimum metric class 8.8 specification.

Kolpin Outdoors, Inc.

Telephone: (763)-478-5800

Toll Free: (877)-956-5746

Fax Number: (800)-245-7569

www.kolpin.com

Email: customerservice@kolpin.com